

KEROS

ACTUAL

2022

ÍNDICE

ÍNDICE	02
PORCELÁNICO	04
GRES	102
REVESTIMIENTO	106
ICONOGRAFÍA	176
DESTONIFICADO	176
PACKING	177
COLOCACIONES DE LA SERIE MODULA	178
PIEZAS ESPECIALES	180
CARACTERÍSTICAS TÉCNICAS	182
ANTIDESLIZANTE	184
LIMPIEZA Y MANTENIMIENTO	188
RESERVA DE DERECHOS	189
CONSEJOS COLOCACIÓN	189

MODULA	
ABADÍA	06
AUGUSTA	08
BIERZO	10
PORTOBELLO	12
50X100CM/19,7"X39,4"	
AMALFI	14
DOVER	16
FERRARA	18
MARMI	20
NUBA	22
PARK	24
PORTOBELLO	26
80X80CM/31,5"X31,5"	
ARDENZA	28
BONN	30
CANADA	32
COTTO	34
DAFNE	36
HALIFAX	38
HAT	40
LONDON	42
QUEBEC	44
REGINA	44
VERNAZZA	46
75X75CM/ 29,5"X 29,5"	
URBAN	46
50X50CM/19,7"X19,7"	
ABADÍA	48
BLUESTONE	50
PORTLAND	52-140 -152-154 -163-170
PORTOBELLO	54
45X45CM/ 17,71"X 17,71"	
CARTAGO	138
CITY	140
VERNAZZA	134-176

PORCELÁNICO

33X67CM/13,0"X26,4"	
AMALFI	56
ARDENZA	58
BIERZO	60
BLUESTONE	50
FERRARA	62
NEW YORK	64
NUBA	66
PORTLAND	52
PORTOBELLO	54
POTES	68
REDSTONE	70
STRATA	72
SUNROCK	72
33X33CM/13,0"X13,0"	
ARES	92
DOLOMITE	120
NEW YORK	64
POTES	68
REDSTONE	70
PELDAÑOS	94
33X33CM·SLIM/13,0"X13,0"·SLIM	
GUDAR	96
MURTA	98
PIRINEOS	100
23X100CM/9"X39,4"	
AKELARRE	78
BANAK	80
HAYEDO	82
SIA	84
TRIBECA	86
23X46CM / 9,1"X18,1"	
PIEDRA	74
ROCK	76
8X67CM / 3,14"X26,4"	
BACKWOOD	88
OXFORD	90

GRES

33X33CM/13,0"X13,0"	
BASIC	166
BRANCATO	148
GREDOS RECTO	104
MARMI BIANCO	144-156
RONDA	104
ROYAL	160
SINTRA	106-175

REVESTIMIENTO

40X120CM/ 15,75"X47,24"	
AGORA	110
CALGARY	112
SUPERWHITE	114
TREND	116

30X90CM/11,8"X25,4"	
ARDENZA	118
CORINTO	120
EXPRESSION	122
LIVORNO	124
LONDON	126
PEONÍA	128
TARENTO	130
TEBAS	132
VERNAZZA	134
WHITE	136

25X75CM/9,8"X29,5"	
CARTAGO	138
CITY	140
WHITE	142

30X60CM/11,8"X23,6"	
ALMA	144
BLANCOS	146
BRANCATO	148
CANVAS	150
LONDON	152
DENVER	154
MARMI BIANCO	156
NATURA	158
ROYAL	160
SANTRI	162
SOUL	144

20X50CM/7,87"X19,7"	
BLANCOS	146
CARPI	164
D&N SUGAR/DUNE	166
D&N SUITE/STAR	166
LAND	168
NATURA	170
PERSONALITY	172
SINTRA	174
VERNAZZA	176

PORCELÁNICO

PORCELANICO

Más información en nuestra web: www.keros.com / For more information: www.keros.com



MODULA ABADÍA

2pz 50x50 cm, 2pz 25x50 cm, 4pz 25x25 cm
2pc 19,7"x19,7", 2pc 9,8x19,7"x 4pc 9,8"x9,8"



Modula Abadía Avena
MODULA
MODULA · Antislip

M164
M166



Modula Abadía Centeno
MODULA
MODULA · Antislip

M164
M166

PORCELÁNICO



| Modula Augusta Beige · Antislip |

MODULA AUGUSTA

2pz 50x50 cm, 2pz 25x50 cm, 4pz 25x25 cm
2pc 19,7"x19,7", 2pc 9,8x19,7"x 4pc 9,8"x9,8"



Modula Augusta Beige
MODULA
MODULA · Antislip

M164
M166



MODULA BIERZO

2pz 50x50 cm, 2pz 25x50 cm, 4pz 25x25 cm
2pc 19,7"x19,7", 2pc 9,8x19,7"x 4pc 9,8"x9,8"



Modula Bierzo Mix
MODULA
MODULA - Antislip

M164
M166



MODULA PORTOBELLO

2pz 50x50 cm, 2pz 25x50 cm, 4pz 25x25 cm
 2pc 19,7"x19,7", 2pc 9,8x19,7"x 4pc 9,8"x9,8"



Modula Portobello Ivory
 MODULA
 MODULA · Antislip

M164
 M166



Modula Portobello Taupe
 MODULA
 MODULA · Antislip

M164
 M166



Modula Portobello Silver
 MODULA
 MODULA · Antislip

M164
 M166



Peldaño Extrusionado Portobello Taupe
 33x33 cm · Antislip P260

*Ejemplos de modulos en la pag. 180.
 Module examples on the 180.



AMALFI

50x100 cm / 19,7"x39,4"



Amalfi Gris
50x100 cm
50x100 cm · Antislip

M131
M130



Amalfi Foro Gris
50x100 cm

M131



Amalfi Beige
50x100 cm
50x100 cm · Antislip

M131
M130



Amalfi Foro Beige
50x100 cm

M131



Amalfi Taupe
50x100 cm
50x100 cm · Antislip

M131
M130



Amalfi Foro Taupe
50x100 cm

M131

PORCELÁNICO RECTIFICADO



| Dover Gris 50x100 cm | Dover Acero 50x100 cm |

DOVER

50x100 cm / 19,7"x39,4"



Dover Beige
50x100 cm

M081



Dover Gris
50x100 cm
50x100 cm · Antislip

M081
M130



CB

Dover Acero
50x100 cm · COLOR BODY

M092



CB

Dover Negro
50x100 cm · COLOR BODY

M092



FERRARA

50x100 cm / 19,7"x39,4"



Ferrara Gris
50x100 cm
50x100 cm · Antislip

M081
M130



Ferrara Foro Gris
50x100 cm

M131



Ferrara Acero
50x100 cm
50x100 cm · Antislip

M081
M130



Ferrara Foro Acero
50x100 cm

M131



Ferrara Beige
50x100 cm
50x100 cm · Antislip

M081
M130



Ferrara Foro Beige
50x100 cm

M131

PORCELÁNICO RECTIFICADO



| Marmi Bianco 50x100 cm | Mosaico Bierzo Negro 30x30 |

MARMI

50x100 cm / 19,7"x39,4"



Marmi Bianco
50x100 cm

M081

PORCELÁNICO RECTIFICADO



| Nuba Blanco 50x100 cm | Decorado Nuba Geo 50x100 cm |

NUBA

50x100 cm / 19,7"x39,4"



Nuba Blanco
50x100 cm

M081



Decorado Nuba Geo
50x100 cm

M131

PORCELÁNICO RECTIFICADO



| Park Steel 50x100 cm | Park Gris 50x100 cm | Mosaico Park Silver 30x30 cm |

PARK

50x100 cm / 19,7"x39,4"



Park Gold
50x100 cm

M081



Park Silver
50x100 cm

M081



Parl Steel
50x100 cm

M081



Mosaico Park Gold
30x30 (5x5) cm P180



Mosaico Park Silver
30x30 (5x5) cm P180

PORCELÁNICO RECTIFICADO



| Portobello Ivory 50x100 cm | Portobello Foro Ivory 50x100 cm |

PORTOBELLO

50x100 cm / 19,7"x39,4"



Portobello Ivory
50x100 cm

M081



Portobello Foro Ivory
50x100 cm

M131



Portobello Taupe
50x100 cm

M081



Portobello Foro Taupe
50x100 cm

M131



Portobello Silver
50x100 cm

M081



Portobello Foro Silver
50x100 cm

M131

PORCELÁNICO RECTIFICADO



| Ardenza Mate 80x80 cm |

ARDENZA

80x80 cm / 31,5"x31,5"



Ardenza Brillo
80x80 cm

A090



Ardenza Mate
80x80 cm

A091

PORCELÁNICO RECTIFICADO



| Bonn Gris 80x80 cm |

BONN

80x80 cm / 31,5"x31,5"

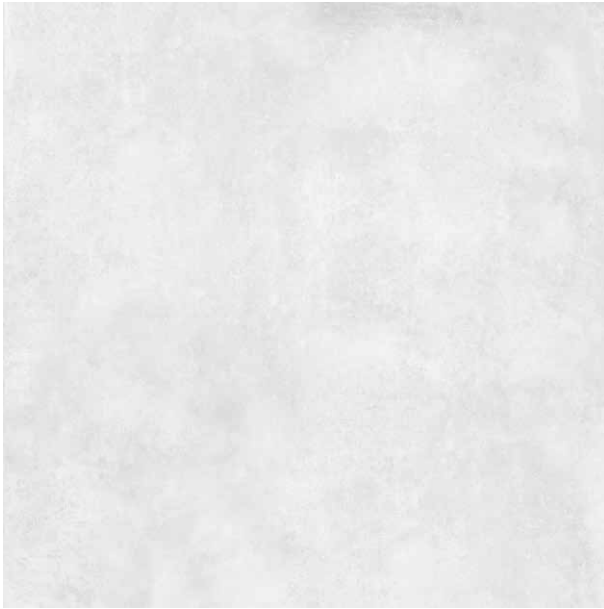

Bonn Gris
80x80 cm

A091



Bonn Acero
80x80 cm

A091



Bonn Beige
80x80 cm

A091

PORCELÁNICO RECTIFICADO



| Canada Roble 80x80 cm |

CANADA

80x80 cm / 31,5"x31,5"



Canada Roble
80x80 cm

A091

5 diseños diferentes / 5 different designs



COTTO

80x80 cm / 31,5"x31,5"

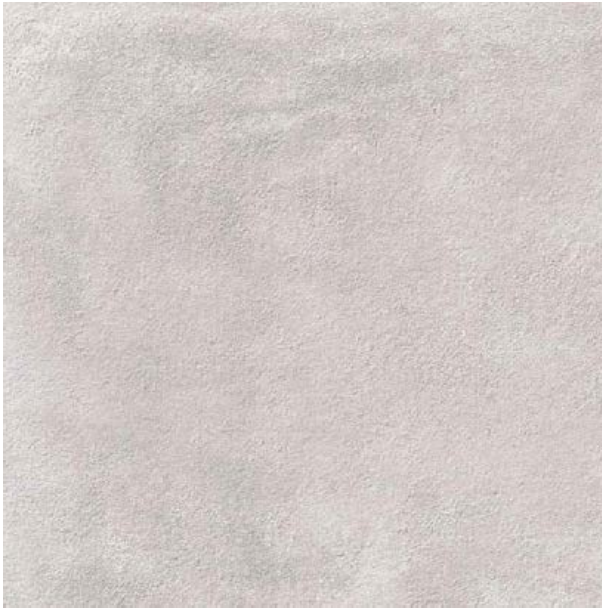

Cotto Gris
80x80 cm
80x80 cm · Antislip

A091
A097



Cotto Acero
80x80 cm

A091

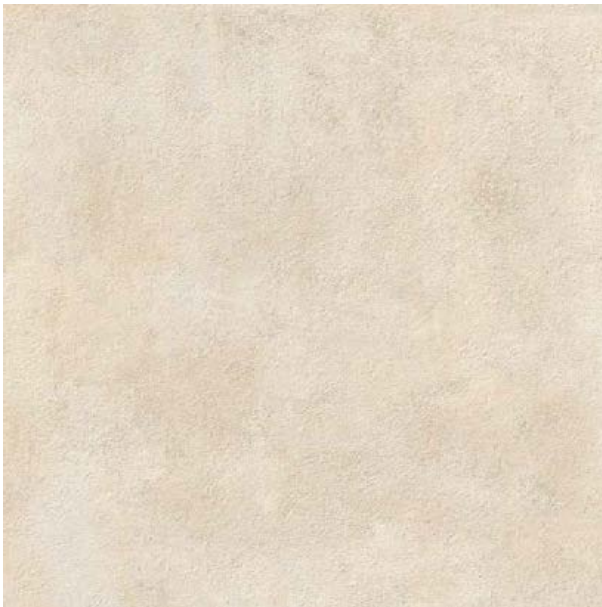

Cotto Beige
80x80 cm
80x80 cm · Antislip

A091
A097



Cotto Cuero
80x80 cm

A091

PORCELÁNICO RECTIFICADO



| Dafne Negro 80x80 cm |

DAFNE

80x80 cm / 31,5"x31,5"



Dafne Gris
80x80 cm

A091



Dafne Negro
80x80 cm

A091



Dafne Beige
80x80 cm

A091



Dafne Taupe
80x80 cm

A091

PORCELÁNICO RECONOCIDO



| Halifax 80x80 cm |

HALIFAX

80x80 cm / 31,5"x31,5"

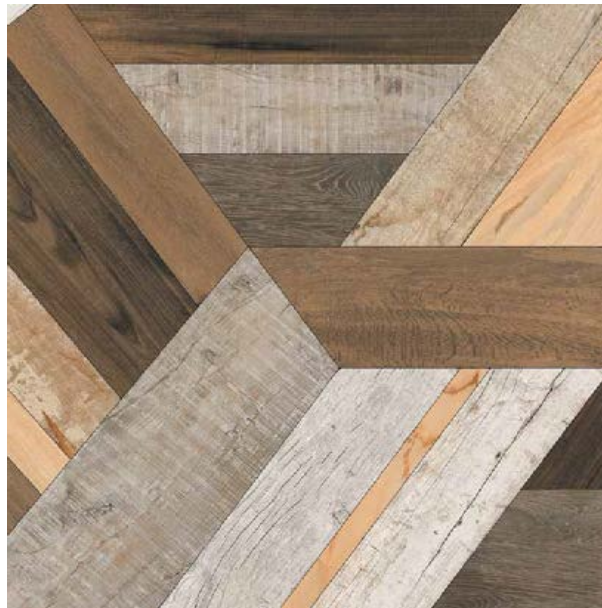

Halifax
80x80 cm

A091

8 diseños diferentes / 8 different designs

PORCELÁNICO RECTIFICADO



| Hat Blanco 80x80 cm |

HAT

80x80 cm / 31,5"x31,5"

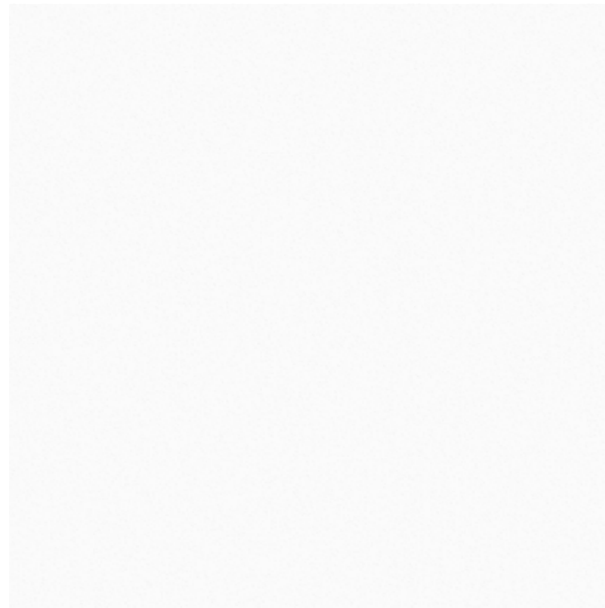

Hat Blanco
80x80 cm

A096

PORCELÁNICO RECTIFICADO



| London Gris 80x80 cm |

LONDON

80x80 cm / 31,5"x31,5"

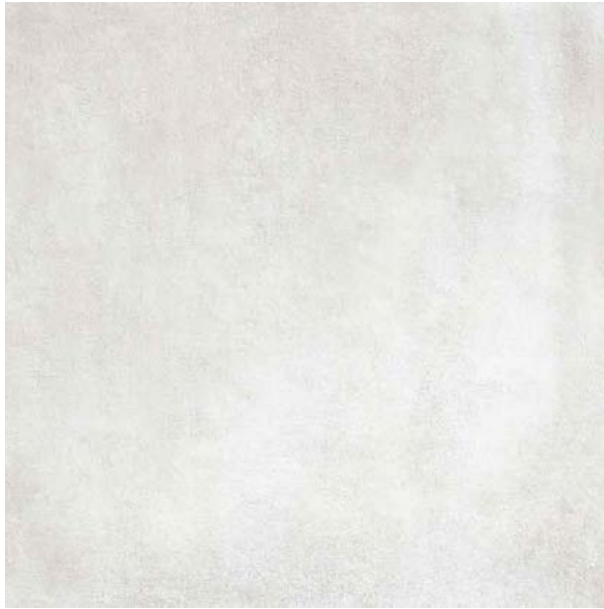

London Gris
80x80 cm

A091

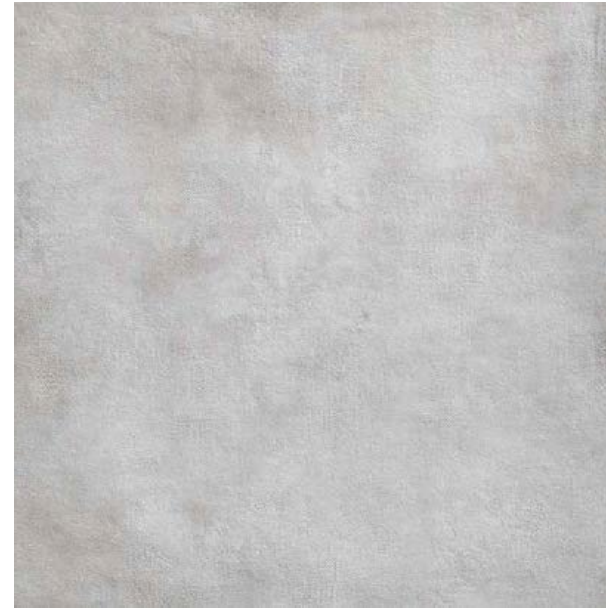

London Acero
80x80 cm

A091

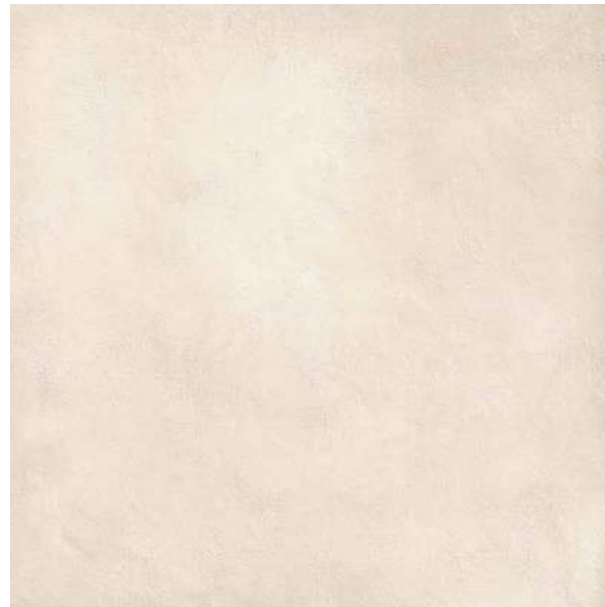

London Beige
80x80 cm

A091

PORCELÁNICO RECTIFICADO



| Quebec 80x80 cm |

QUEBEC

80x80 cm / 31,5"x31,5"



Quebec
80x80 cm

A090

REGINA

80x80 cm / 31,5"x31,5"



Regina
80x80 cm

A091

PORCELÁNICO



| Urban Perla 75x75 cm |

VERNAZZA

80x80 cm / 31,5"x31,5"



Vernazza Negro
80x80 cm

A091

URBAN

75x75 cm / 29,5"x29,5"



Urban Perla
75x75cm
75x75cm · Antislip

T006
T012



Urban Acero
75x75cm
75x75cm · Antislip

T006
T012



ABADÍA

50x50 cm / 19,7"x19,7"



Abadía Avena
50x50 cm
50x50 cm - Antislip

M085
M111



Abadía Centeno
50x50 cm
50x50 cm - Antislip

M085
M111

PORCELÁNICO



| Bluestone Negro 50x50 cm. |

BLUESTONE

50x50 cm - 33x67 cm / 19,7"x39,4" - 12,9"x26,3"

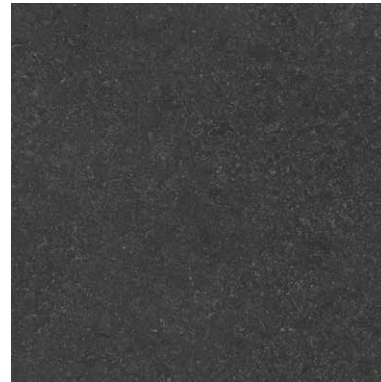

Bluestone Negro
50x50 cm · COLOR BODY

M126



Bluestone Negro
33x67 cm · COLOR BODY

M127

PORCELÁNICO



| Portland-Noce 50x50 cm | Portland-Beige 33x67 cm | Decorado Horizon Beige 33x67 cm |

PORTLAND

50x50 cm - 33x67 cm / 19,7"x39,4" - 12,9"x26,3"



Portland Gris
33x67 cm

M018



Portland Gris
50x50 cm

M085



Portland Beige
33x67 cm

M018



Portland Beige
50x50 cm

M085



Portland Acero
33x67 cm

M018



Portland Acero
50x50 cm

M085



Portland Noce
33x67 cm

M018



Portland Noce
50x50 cm

M085



Portland Antracita
33x67 cm

M018



Decorado Horizon Beige
33x67 cm

M029



Decorado Horizon Gris
33x67 cm

M029



Portland Antracita
50x50 cm

M085



PORTOBELLO

50x50 cm - 33x67 cm / 19,7"x39,4" - 12,9"x26,3"



Portobello Ivory
50x50 cm
50x50 cm - Antislip

M085
M111



Portobello Taupe
50x50 cm
50x50 cm - Antislip

M085
M111



Portobello Silver
50x50 cm
50x50 cm - Antislip

M085
M111



Portobello Ivory
33x67 cm
33x67 cm - Antislip

M018
M112



Portobello Taupe
33x67 cm
33x67 cm - Antislip

M018
M112



Portobello Silver
33x67 cm
33x67 cm - Antislip

M018
M112



Peldaño Extrusionado Portobello Taupe
33x33 cm - Antislip P260

PORCELÁNICO



| Amalfi Gris 33x67 cm. | Amalfi Gris - Antislip 33x67 | Amalfi Bard Gris 33x67 cm |

AMALFI

33x67 cm / 13"x26,4"



Amalfi Gris
33x67cm
33x67cm · Antislip

M018
M112



Amalfi Band Gris
33x67 cm

M029



Amalfi Beige
33x67cm
33x67cm · Antislip

M018
M112



Amalfi Band Beige
33x67 cm

M029



Amalfi Taupe
33x67cm
33x67cm · Antislip

M018
M112



ARDENZA

33x67 cm / 13"x26,4"



Ardenza Gold
33x67

M018



Ardenza Mix Gold
33x67 cm

M029



Mosaico Ardenza Gold
30x30 (5x5) cm P180

PORCELÁNICO



Bronzo Mix 33x62 cm

BIERZO

33x67 cm / 13"x26,4"

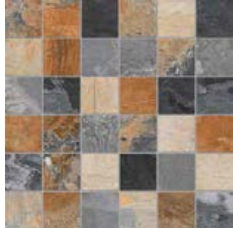

Mosaico Bierzo Mix
30x30P (5x5) cm * P180



Bierzo Mix
33x67 cm
33x67 cm - Antislip

M018
M112

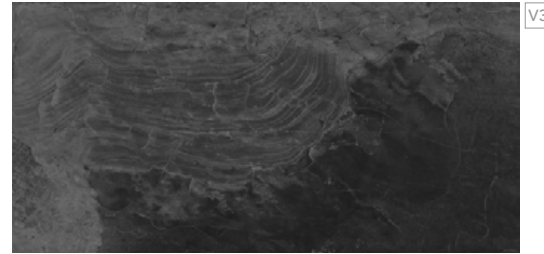

Bierzo Negro
33x67 cm
33x67 cm - Antislip

M018
M112

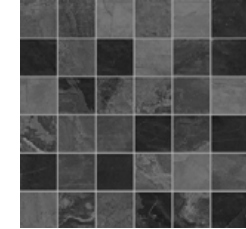

Mosaico Bierzo Negro
30x30P (5x5) cm * P180

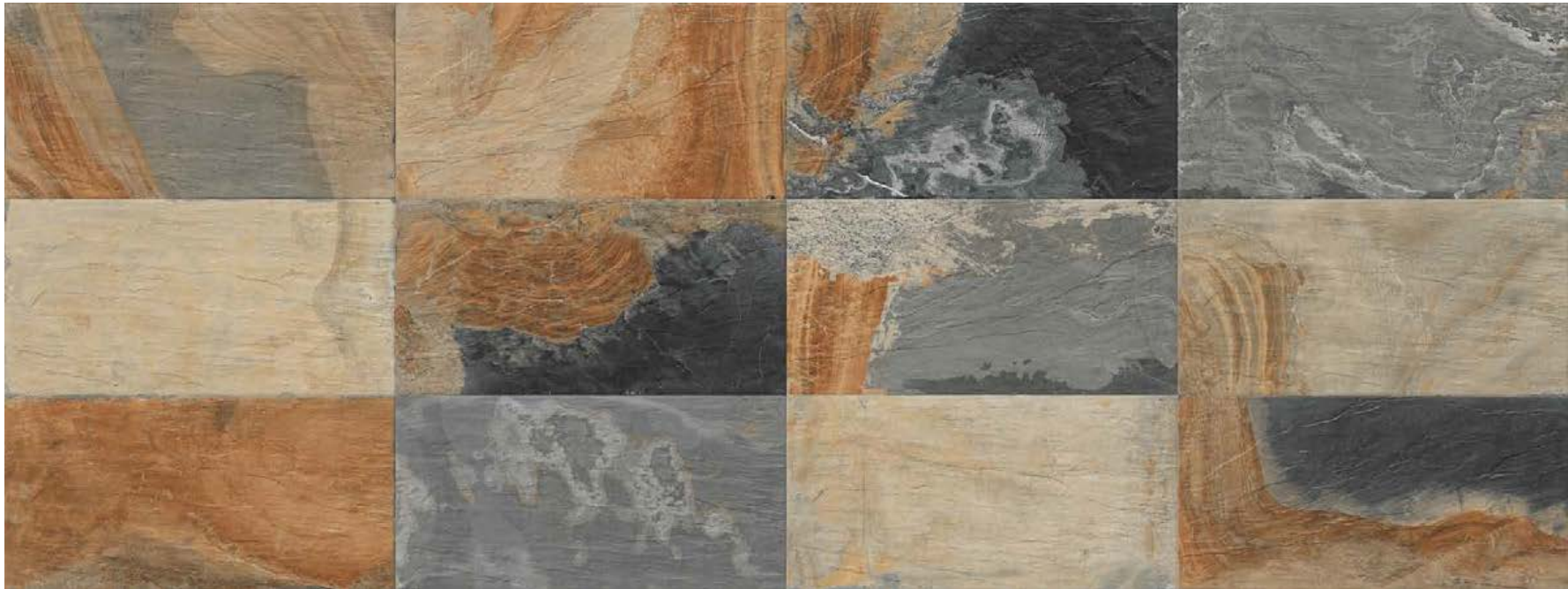

Gráfica Bierzo Mix 33x67

PORCELÁNICO



| Ferrara Acero Antislip 33x67 cm | Ferrara Acero 33x67 cm |

FERRARA

33x67 cm / 13"x26,4"



Ferrara Beige
33x67cm
33x67cm - Antislip

M018
M112



Ferrara Gris
33x67cm
33x67cm - Antislip

M018
M112



Ferrara Acero
33x67cm
33x67cm - Antislip

M018
M112



Ferrara Espiga Beige
33x67 cm

M029



Ferrara Espiga Gris
33x67 cm

M029



Ferrara Espiga Acero
33x67 cm

M029

PORCELÁNICO



| New York Beige 33x67 cm |

NEW YORK

33x67 - 33x33 cm / 13"x26,4" - 13"x13"



New York Beige
33x67cm · Antislip

M018



New York Teja
33x67cm · Antislip

M018



New York Musgo
33x67cm · Antislip

M018



New York Beige
33x33cm · Antislip

M073



New York Teja
33x33cm · Antislip

M073



New York Musgo
33x33cm · Antislip

M073



Peldaño Extrusionado New York Musgo
33x33 cm · Antislip P260

PORCELÁNICO



| Nuba Blanco 33x67 cm | Decorado Nuba Blanco 33x67 cm |

NUBA

33x67 cm / 13"x26,4"



Nuba Blanco
33x67cm

M018



Decorado Nuba Blanco
33x67 cm

M029



Nuba Ona Blanco
33x67 cm

M029



POTES

33x67 - 33x33 cm / 13"x26,4" - 13"x13"



Potes Taupe
33x67cm · Antislip

T014



Potes Acero
33x67cm · Antislip

T014



Potes Cuero
33x67cm · Antislip

T014



Potes Negro
33x67cm · Antislip

T014



Potes Taupe
33x33cm · Antislip

T013



Potes Cuero
33x33cm · Antislip

T013



Potes Acero
33x33cm · Antislip

T013



Potes Negro
33x33cm · Antislip

T013



REDSTONE

33x67 - 33x33 cm / 13"x26,4" - 13"x13"



Redstone Beige
33x67cm · Antislip

T014



Redstone Gris
33x67cm · Antislip

T014



Redstone Crema
33x67cm · Antislip

T014



Redstone Acero
33x67cm · Antislip

T014



Redstone Beige
33x33cm · Antislip

T013



Redstone Crema
33x33cm · Antislip

T013



Redstone Gris
33x33cm · Antislip

T013

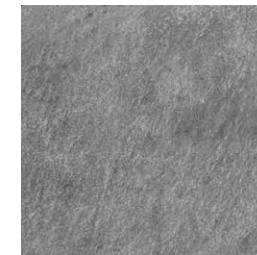

Redstone Acero
33x33cm · Antislip

T013



Peldaño Extrusionado Redstone Beige
33x33 cm · Antislip

P260



Peldaño Extrusionado Redstone Crema
33x33 cm · Antislip

P260



Peldaño Extrusionado Redstone Gris
33x33 cm · Antislip

P260



Peldaño Extrusionado Redstone Acero
33x33 cm · Antislip

P260

PORCELÁNICO



| Sunrock Blanco 33x67 cm |

STRATA

33x67 cm / 13"x26,4"



V3

Strata Silver
33x67cm

M029

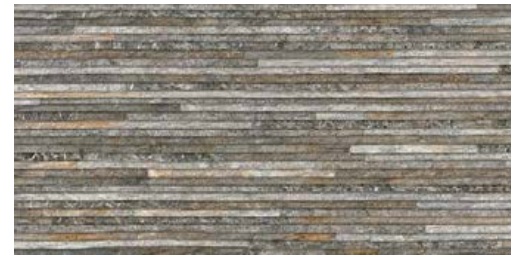

V3

Strata Gris
33x67cm

M029



V3

Strata Beige
33x67cm

M029



Strata Blanco
33x67cm

M029

SUNROCK

33x67 cm / 13"x26,4"



Sunrock Blanco
33x67cm

M018

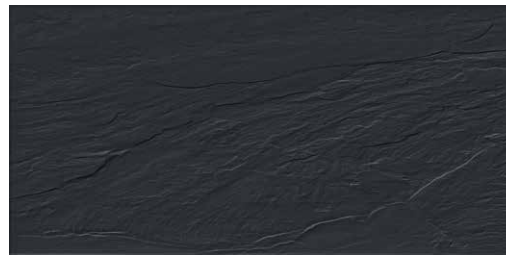

Sunrock Negro
33x67cm

M018



Mosaico Sunrock Blanco
30x30 (5x5) cm

P180



Mosaico Sunrock Negro
30x30 (5x5) cm

P180

PORCELÁNICO



| Piedra Natural 23x46 cm |

PIEDRA

23x46 cm / 9"x18,1"



V4

Piedra Natural
23x46cm

A066



V4

Piedra Mix
23x46cm

A066



V3

Piedra Gris
23x46cm

A066

PORCELÁNICO



Rock Beige 3x46 cm |

ROCK

23x46 cm / 9"x18,1"



Rock Beige
23x46cm

A066



Rock Cuero
23x46cm

A066



Rock Gris
23x46cm

A066

PORCELÁNICO



| Akelarre Noce 23x100 cm |

AKELARRE

23x100 cm / 9"x39,4"



Akelarre Beige
23x100 cm
23x100 cm · Rectificado

T015
T017



Akelarre Noce
23x100 cm
23x100 cm · Rectificado

T015
T017



Akelarre Gris
23x100 cm
23x100 cm · Rectificado

T015
T017



Akelarre Acero
23x100 cm
23x100 cm · Rectificado

T015
T017

PORCELÁNICO



(Sarak Beige 23x100 cm) (Sarak Star Beige 23x100 cm)

BANAK

23x100 cm / 9"x39,4"



Banak Beige
23x100 cm
23x100 cm · Antislip
23x100 cm · Rectificado
23x100 cm · Rectificado · Antislip

T015
T016
T017
T018



Banak Star Beige
23x100 cm

T020



Banak Blanco
23x100 cm
23x100 cm · Antislip
23x100 cm · Rectificado
23x100 cm · Rectificado · Antislip

T015
T016
T017
T018



Banak Star Blanco
23x100 cm

T020



Banak Gris
23x100 cm
23x100 cm · Antislip
23x100 cm · Rectificado
23x100 cm · Rectificado · Antislip

T015
T016
T017
T018



Banak Star Gris
23x100 cm

T020

PORCELÁNICO



| Hayedo Roble - Artista 13x100 cm | Hayedo Roble 23x100 cm |

HAYEDO

23x100 cm / 9"x39,4"



Hayedo Almond	T015
23x100 cm	T016
23x100 cm · Antislip	T017
23x100 cm · Rectificado	T018
23x100 cm · Rectificado · Antislip	



Hayedo Roble	T015
23x100 cm	T016
23x100 cm · Antislip	T017
23x100 cm · Rectificado	T018
23x100 cm · Rectificado · Antislip	



Hayedo Gris	T015
23x100 cm	T016
23x100 cm · Antislip	T017
23x100 cm · Rectificado	T018
23x100 cm · Rectificado · Antislip	



TAKE ME
TO THE
FJORDS

SIA

23x100 cm / 9"x39,4"



Sia Blanco
23x100 cm
23x100 cm · Rectificado

T015
T017



Sia Almond
23x100 cm
23x100 cm · Rectificado

T015
T017



Sia Miel
23x100 cm
23x100 cm · Rectificado

T015
T017



Sia Oliva
23x100 cm
23x100 cm · Rectificado

T015
T017

PORCELÁNICO

Shopping list

- cheese
- milk
- bread
- yoghurt
- dips
- lemon
- wine
- banana
- olive
- veg



TRIBECA

23x100 cm / 9"x39,4"



Tribeca
23x100 cm
23x100 cm · Rectificado

T015
T017

PORCELÁNICO



BACKWOOD

8x67 cm / 3,14"x26,4"



Backwood
8x67 cm

M167

PORCELÁNICO



| Oxford 8x67 cm |

OXFORD

8x67 cm / 3,14"x26,4"



Oxford
8x67 cm

M167



ARES

33x33 cm / 13"x13"



Ares Beige
33x33 cm

M073



Ares Cotto
33x33 cm

M073



Ares Acero
33x33 cm

M073



Peldaño Extrusionado Ares Beige
33x33 cm · Antislip P260



Peldaño Extrusionado Ares Cotto
33x33 cm · Antislip P260



Peldaño Extrusionado Ares Acero
33x33 cm · Antislip P260

PORCELÁNICO



| Redstone Beige · Antislip 33x33 cm | Peldaño Extrusionado Redstone Beige · Antislip 33x33 cm |

PELDAÑOS

33x33 cm / 13"x13"



Peldaño Extrusionado Ares Acero
33x33 cm · Antislip P260



Peldaño Extrusionado Ares Beige
33x33 cm · Antislip P260



Peldaño Extrusionado Ares Cotto
33x33 cm · Antislip P260



Peldaño Extrusionado Redstone Gris
33x33 cm · Antislip P260



Peldaño Extrusionado Redstone Beige
33x33 cm P260



Peldaño Extrusionado New York Musgo
33x33 cm · Antislip P260



Peldaño Extrusionado Redstone Acero
33x33 cm · Antislip P260



Peldaño Extrusionado Redstone Crema
33x33 cm · Antislip P260



Peldaño Extrusionado Portobello Taupe
33x33 cm · Antislip P260

PORCELÁNICO



| Gudar Avena - SLIM - Antislip - 33x33 cm |

GUDAR

33x33 cm · SLIM / 13"x13" · SLIM



Gudar Avena
33x33cm · SLIM · Antislip T019



Gudar Centeno
33x33cm · SLIM · Antislip T019

PORCELÁNICO



| Murta Gris · SLIM · Antislip 33x33 cm |

MURTA

33x33 cm · SLIM / 13"x13" · SLIM



Murta Beige
33x33cm · SLIM · Antislip T019



Murta Gris
33x33cm · SLIM · Antislip T019



Murta Acero
33x33cm · SLIM · Antislip T019



PIRINEOS

33x33 cm · SLIM / 13"x13" · SLIM



Pirineos Ivory
33x33cm · SLIM · Antislip T019



Pirineos Taupe
33x33cm · SLIM · Antislip T019



Pirineos Silver
33x33cm · SLIM · Antislip T019

GRES

STONEWARE

Más información en nuestra web: www.keros.com / For more information: www.keros.com

33X33CM/13.0"X13.0"

GEDOS RECTO	104
RONDA	104
SINTRA	106

GRES



| Grados Recto Matz 33x33 cm |

GEDOS RECTO

33x33 cm / 13"x13"



Gredos Recto Avena
33x33 cm
33x33 cm - Antislip M010



Gredos Recto Maíz
33x33 cm
33x33 cm - Antislip M010

RONDA

33x33 cm / 13"x13"



Ronda Beige
33x33 cm M046



Ronda Cuero
33x33 cm M046

GRES



| Sintra Silver 33x33 cm |

SINTRA

33x33 cm / 13"x13"



Sintra Arena
33x33 cm · Antislip M072

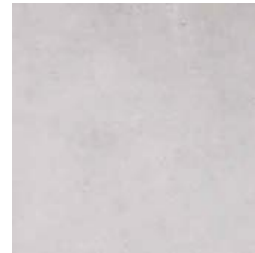

Sintra Silver
33x33 cm · Antislip M072



Sintra Marengo
33x33 cm · Antislip M072

REVESTIMIENTO

WALL TILE

Más información en nuestra web: www.keros.com / For more information: www.keros.com

40X120CM/ 15.75"X47.24"	
AGORA	110
CALGARY	112
SUPERWHITE	114
TREND	116

30X90CM/11.8"X25.4"	
ARDENZA	118
CORINTO	120
EXPRESSION	122
LIVORNO	124
LONDON	126
PEONÍA	128
TARENTO	130
TEBAS	132
VERNAZZA	134
WHITE	136

25X75CM/9.8"X29.5"	
CARTAGO	138
CITY	140
WHITE	142

30X60CM/11.8"X23.6"	
ALMA	144
BLANCOS	146
BRANCATO	148
CANVAS	150
LONDON	152
DENVER	154
MARMI BIANCO	156
NATURA	158
ROYAL	160
SANTRI	162
SOUL	144

20X50CM/7.87"X19.7"	
BLANCOS	146
CARPI	164
D&N SUGAR/DUNE	166
D&N SUITE/STAR	166
LAND	168
NATURA	170
PERSONALITY	172
SINTRA	174
VERNAZZA	176

WHITE BODY



| Agora Gris 40x120 cm | Agora Brick Gris 40x120 cm | Banak Gris 23x100 cm |

AGORA

40X120 cm / 15,7"x47,2"



Agora Gris
40x120 cm

M115



Agora Beige
40x120 cm

M115



Agora Brick Gris
40x120 cm

M116



Agora Brick Beige
40x120 cm

M116

WHITE BODY



| Calgary Bianco 40x120 cm | Decorado Calgary Bianco 40x120 cm |

CALGARY

40X120 cm / 15,7"x47,2"

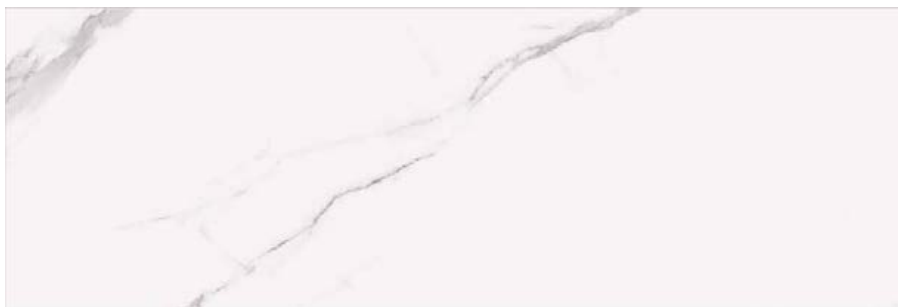

Calgary Bianco
40x120 cm

M115

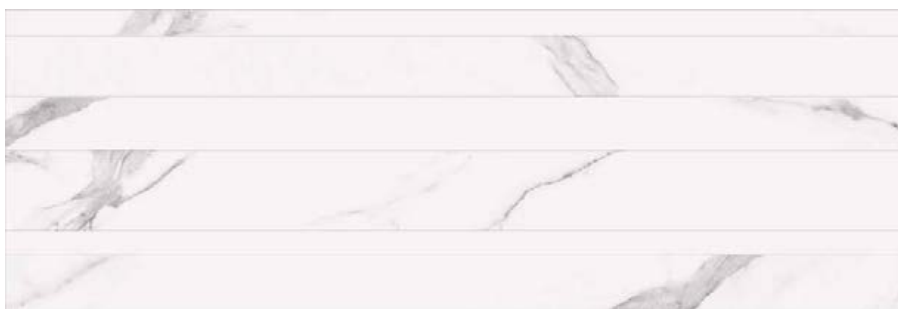

Decorado Calgary Bianco
40x120 cm

M116

WHITE BODY



| Superwhite 40x120 cm | Listelo Metal 1x100 cm

SUPERWHITE

40X120 cm / 15,7"x47,2"

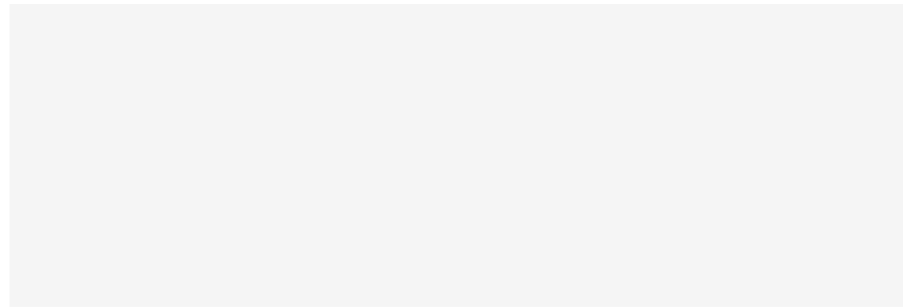

Superwhite
40x120 cm

M115

Listelo Metal
1x100 cm (price per pc)

P135

WHITE BODY



| Trend Gris 40x120 cm | Trend Wave Gris 40x120 cm | Bonn Acero 80x80 cm |

TREND

40X120 cm / 15,7"x47,2"

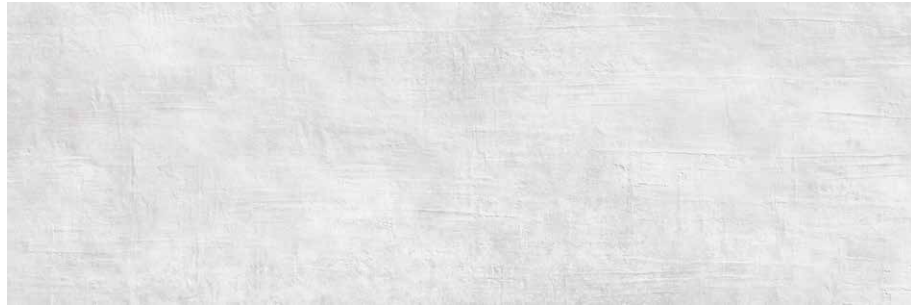

Trend Gris
40x120 cm

M115

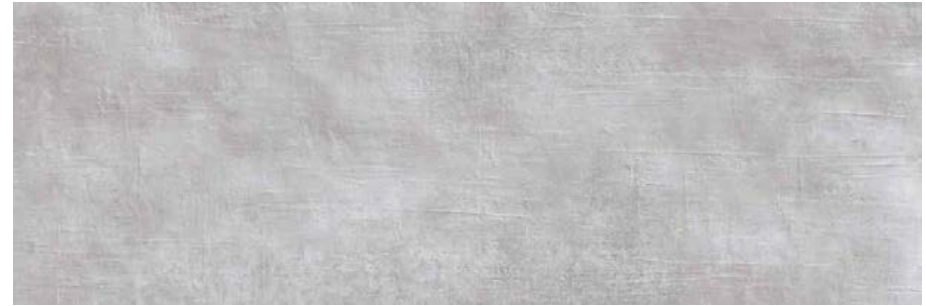

Trend Acero
40x120 cm

M115

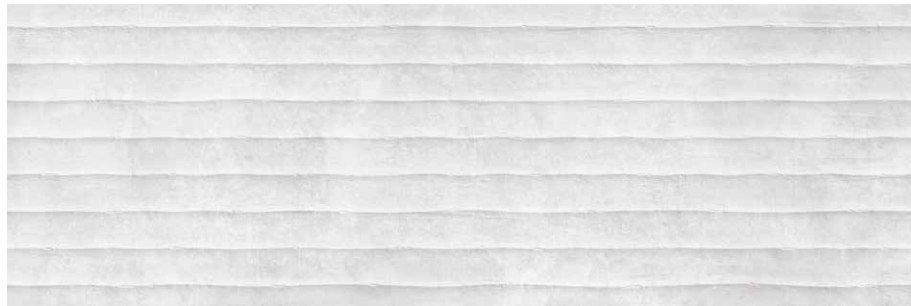

Trend Wave Gris
40x120 cm

M116

WHITE BODY



| Ardenza Mate 30x90 cm | Ardenza Hexa Mate 30x90 cm |

ARDENZA

30x90 cm / 11,8"x35,4"



Ardenza Brillo
30x90 cm

A098



Ardenza Mate
30x90 cm

A075



Ardenza Lines Brillo
30x90 cm

A099



Ardenza Hexa Mate
30x90 cm

A078



Ardenza Sea Mate
30x90 cm

A078

WHITE BODY



Colinto Gris 30x90 cm | Colinto Shade Gris 30x90 cm |

CORINTO

30x90 cm / 11,8"x35,4"



Corinto Gris
30x90 cm

A075



Corinto Shade Gris
30x90 cm

A078

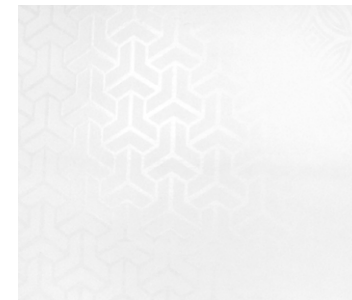

Detalle Corinto Shade Gris.



Corinto Sea Gris
30x90 cm

A078



Dolomite Gris
33x33P cm

A004

WHITE BODY



| Expression Blanco 30x90 cm | Expression Tri Blanco 30x90 cm |

EXPRESSION

30x90 cm / 11,8"x35,4"

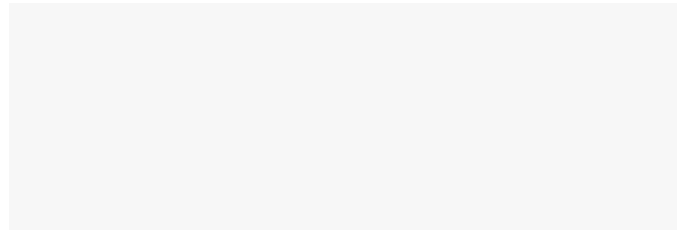

Expression Blanco
30x90 cm

A075

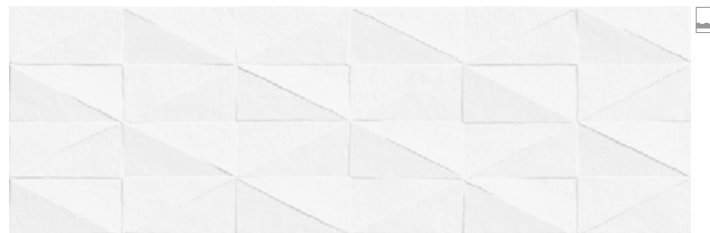

Expression Foro Blanco
30x90 cm

A078



Expression Tri Blanco
30x90 cm

A078

WHITE BODY



| Livorno Gris 30x90 cm | Livorno Lines Gris 30x90 cm |

LIVORNO

30x90 cm / 11,8"x35,4"



Livorno Gris
30x90 cm

A098



Livorno Kentia Gris
30x90 cm

A099



Livorno Lines Gris
30x90 cm

A099

WHITE BODY



| London Gris 30x90 cm | Decórado London Tri Gris 30x90 cm |

LONDON

30x90 cm / 11,8"x35,4"



London Blanco
30x90 cm

A075



Decorado London Tri Gris
30x90 cm

A078



London Gris
30x90 cm

A075



Decorado Lontano Gris
30x90 cm

A078



London Acero
30x90 cm

A075



Decorado London Eye Blanco/ Gris/ Acero
30x90 cm

A078



Decorado London Hidráulico
30x90 cm

A078

TE BODY



| Peonia Rosa 30x90 cm | London Blanco 30x90 cm |

PEONIA

30x90 cm / 11,8"x35,4"



Peonia Azul
30x90 cm

A078



Peonia Rosa
30x90 cm

A078

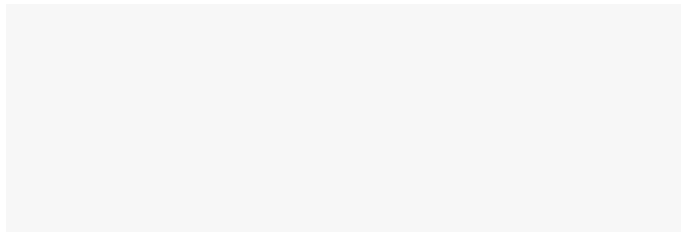

White Mate
30x90 cm

A075



London Blanco
30x90 cm

A075

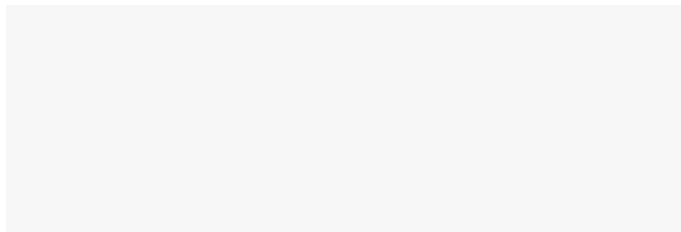

Expression Blanco
30x90 cm

A075

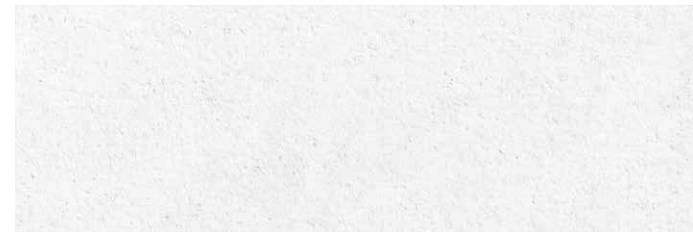

Tarento Blanco
30x90 cm

A075

WHITE BODY



Tarento Gris 30x90 cm | Foro Gris 30x90 cm |

TARENTO

30x90 cm / 11,8"x35,4"



Tarento Blanco
30x90 cm

A075



Decorado Tarento Eye Blanco
30x90 cm

A078

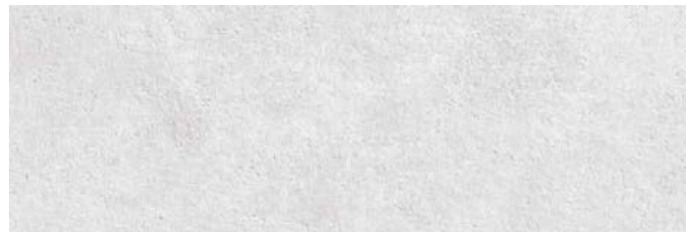

Tarento Gris
30x90 cm

A075



Decorado Lontano Gris / Beige
30x90 cm

A078

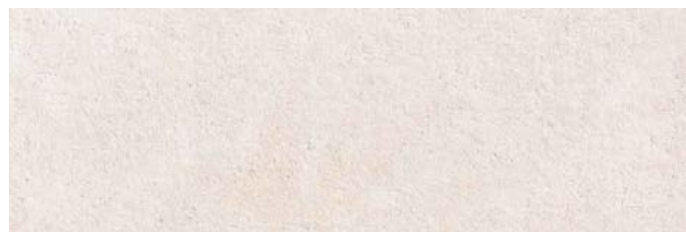

Tarento Beige
30x90 cm

A075



Foro Beige / Gris
30x90 cm

A078

WHITE BODY



| Tebas Gris 30x90 cm | Tebas Mix Gris 30x90 cm |

TEBAS

30x90 cm / 11,8"x35,4"



Tebas Gris
30x90 cm

A075



Tebas Mix Gris
30x90 cm

A078



Tebas Sea Gris
30x90 cm

A078

WHITE BODY



| Vernazza Negro 30x90 cm | Vernazza Blanco 30x90 cm | Vernaza Doria 30x90 cm | Vernazza Blanco 45x45 cm |

VERNAZZA

30x90 cm / 11,8"x35,4"



Vernazza Blanco
30x90 cm

A075



Vernazza Negro
30x90 cm

A075



Vernazza Doria
30x90 cm

A078



Vernazza Regio
30x90 cm

A078



Vernazza Blanco
45x45 cm

A033



Vernazza Negro
45x45 cm

A033

WHITE BODY



| White Mate 30x90 cm | White Sea Mate 30x90 cm |

WHITE

30x90 cm / 11,8"x35,4"



White Brillo
30x90 cm

A098

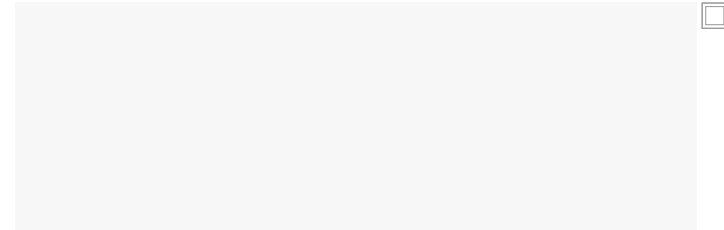

White Mate
30x90 cm

A075

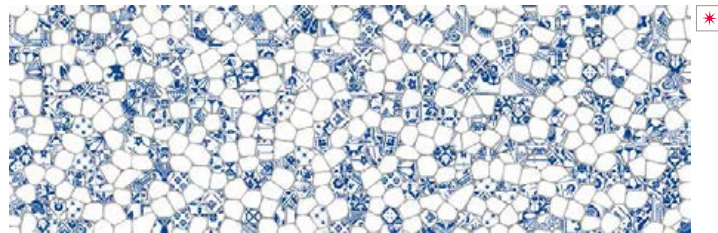

White Gaudí Brillo
30x90 cm

A099



White Sea Mate
30x90 cm

A078



White Lines Brillo
30x90 cm

A099



WHITE BODY

Cartago Beige 25x75 cm | Decorado Cartago Cubik Beige 25x75 cm | Cartago Beige 45x45 cm

CARTAGO

25x75 cm / 9.8"x29,5"



Cartago Beige
25x75 cm

A068

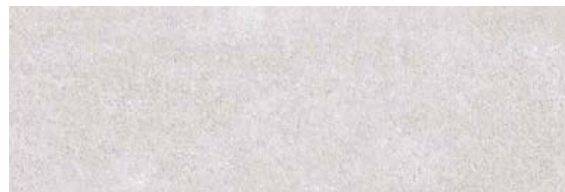

Cartago Gris
25x75 cm

A068



Decorado Cartago Cubik Beige
25x75 cm

A071



Decorado Cartago Cubik Gris
25x75 cm

A071



Decorado Medina Beige
25x75 cm

A071

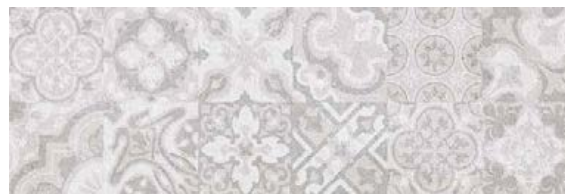

Decorado Medina Gris
25x75 cm

A071



Cartago Beige
45x45 cm

A033



Cartago Gris
45x45 cm

A033



WHITE BODY



* City Beige 25x75 cm / Decorado Walk Nuce 20x75 cm

CITY

25x75 cm / 9.8"x29,5"



City Gris
25x75 cm

A068



Decorado City Dune Gris
25x75 cm

A071



Decorado City Hojas Gris
25x75 cm

A071



City Beige
25x75 cm

A068



Decorado City Dune Beige
25x75 cm

A071



Decorado City Hojas Beige
25x75 cm

A071



City Noce
25x75 cm

A068



Decorado Walk Noce
25x75 cm

A071



Portland Acero / Noce
50x50 cm

M085



City Acero
25x75 cm

A068



Decorado Walk Acero
25x75 cm

A071



City Azul
45x45 cm

A033



City Azul
25x75 cm

A068



Decorado Walk Azul
25x75 cm

A071

WHITE BODY



| White Mate 25x75 cm | Decorado White Mate Hojas 25x75 cm |

WHITE

25x75 cm / 9.8"x29.5"



White Liso
25x75 cm

A068

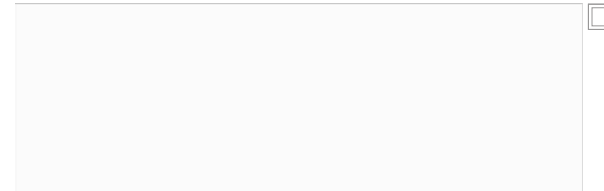

White Mate
25x75 cm

A068



Decorado White Liso Dune
25x75 cm

A071



Decorado White Mate Dune
25x75 cm

A071



Decorado White Liso Hojas
25x75 cm

A071



Decorado White Mate Hojas
25x75 cm

A071

RED BODY



| Alma 30x60 cm | Decorado Alma 30x60 cm |

ALMA

30x60 cm / 11.8"x23,6"



Alma
30x60 cm

T004



Decorado Alma
30x60 cm

T005

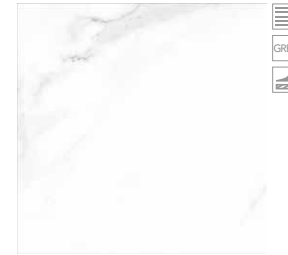

Marmi Bianco
33x33 cm

M072

SOUL

30x60 cm / 11.8"x23,6"



Soul
30x60 cm

T004



Decorado Soul
30x60 cm

T005

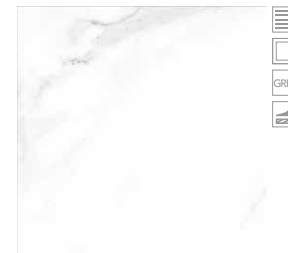

Marmi Bianco
33x33 cm

M072

RED BODY



| Blanco Liso 30x60 cm | Listelo Metal 1x100 cm |

BLANCOS

30x60 cm - 20x50 cm / 11.8"x23.6" - 7.9"x19.7"

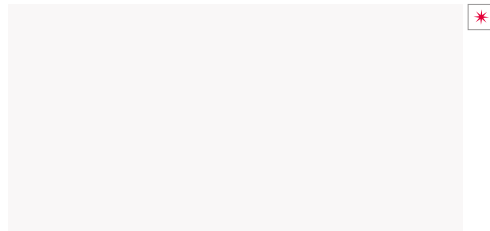

Blanco Liso
30x60 cm

M021

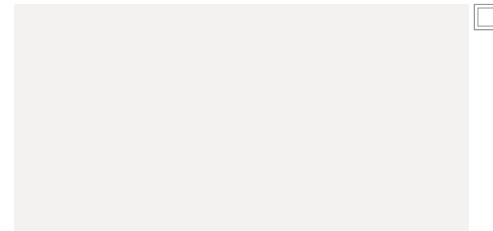

Formal Snow
30x60 cm

M087

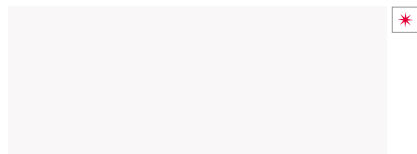

Blanco Liso
20x50 cm

M078

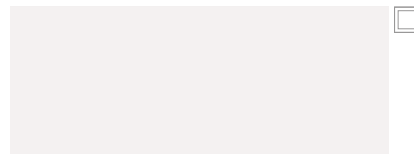

Blanco Mate
20x50 cm

M078



Provence Blanco
20x50 cm

M078

Listelo Metal
1x100 cm (price per pc)

P135

RED BODY



| Brancato Perla 30x60 cm | Brancato Brasil Perla 30x60 cm |

BRANCATO

30x60 cm / 11.8"x23.6"



Brancato Perla
30x60cm

M087



Decorado Brasil Perla
30x60cm

M088



Brancato Beige
30x60cm

M087



Decorado Brasil Beige
30x60cm

M088



Brancato Gris
30x60cm

M087



Decorado Brancato Perla
30x60cm

M088



Brancato Crema
30x60cm

M087

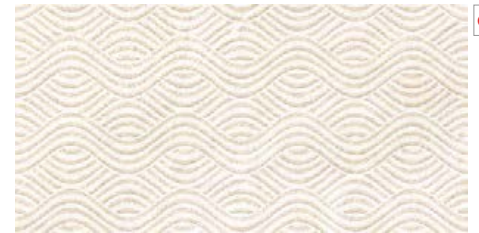

Decorado Brancato Beige
30x60cm

M088



Brancato Gris
33x33cm

M072



Brancato Lim Perla
30x60cm

M088



Brancato Crema
33x33cm

M072



Brancato Lim Beige
30x60cm

M088

RED BODY



Was Beige 30x60 cm | Decorado Pyramid Plus Beige 30x60 cm |

CANVAS

30x60 cm / 11.8"x23,6"



Canvas Beige
30x60 cm

M087



Canvas Gris
30x60 cm

M087



Canvas Blanco
30x60 cm

M087



Decorado Pyramid Beige
30x60 cm

M088



Decorado Pyramid Gris
30x60 cm

M088



Decorado Pyramid Blanco
30x60 cm

M088



Decorado Pyramid Plus Beige
30x60 cm

M122



Decorado Pyramid Plus Gris
30x60 cm

M122



Decorado Canvas Beige
30x60 cm

M122



Decorado Canvas Gris
30x60 cm

M122

RED BODY



| London Beige 30x60 cm | Decorado London Hidráulico Beige 30x60 cm |

LONDON

30x60 cm / 11.8"x23,6"



London Beige
30x60 cm

M087



London Gris
30x60 cm

M087



London Blanco
30x60 cm

M087



London Dune Beige
30x60 cm

M088



London Dune Gris
30x60 cm

M088



London Dune Blanco
30x60 cm

M088

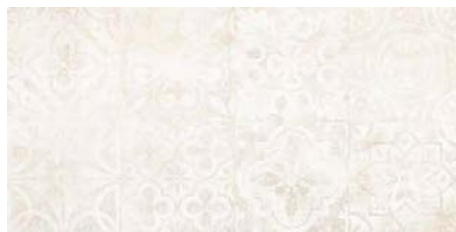

Decorado London Hidráulico Beige
30x60 cm

M088



Decorado London Hidráulico Gris
30x60 cm

M088



Portland Antracita / Acero / Gris / Beige
50x50 cm

M085

RED BODY



| Denver Gris 30x60 cm | Denver Clim Gris 30x60 cm |

DENVER

30x60 cm / 11.8"x23,6"



Denver Beige
30x60cm

M087



Denver Gris
30x60cm

M087



Denver Acero
30x60cm

M087



Denver Climb Beige
30x60cm

M088



Denver Climb Gris
30x60cm

M088



Denver Climb Acero
30x60cm

M088



Portland Beige
50x50 cm

M085



Portland Acero
50x50 cm

M085

RED BODY



| Marmi-Bianco 30x60 cm | Decorado Dune Bianco30x60 cm |

MARMI BIANCO

30x60 cm / 11.8"x23,6"



Marmi Bianco
30x60 cm

M087



Marmi Dune Bianco
30x60 cm

M088

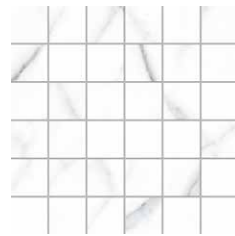

Mosaico Marmi Bianco
30x30 (5x5) cm* P180



Decorado Sec Bianco
20x25 cm*



P250

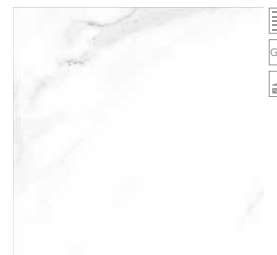

Marmi Bianco
33x33 cm

M072



RED BODY



| Natura Azul 30x60 cm | Natura Gris 30x60 cm | Natura Azul 33x33 cm |

NATURA

30x60 cm / 11.8"x23.6"



Natura Beige
30x60 cm

M087



Natura Gris
30x60 cm

M087



Natura Marrón
30x60 cm

M087



Natura Azul
30x60 cm

M087



Decorado Fusion Marrón
30x60 cm (price per pc)

P435



Decorado Fusion Azul
30x60 cm (price per pc)

P435



ROYAL

30x60 cm / 11.8"x23,6"



Royal Beige
30x60 cm

M087



Royal Perla
30x60 cm

M087

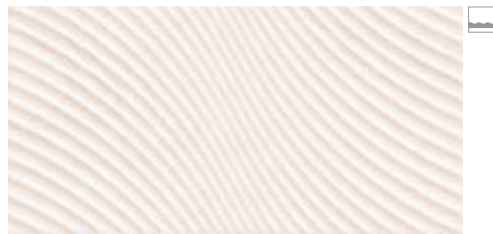

Royal Arquitec Beige
30x60 cm

M088

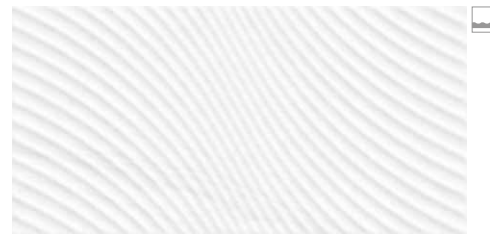

Royal Arquitec Perla
30x60 cm

M088

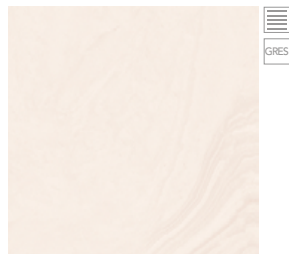

Royal Beige
33x33 cm

M072

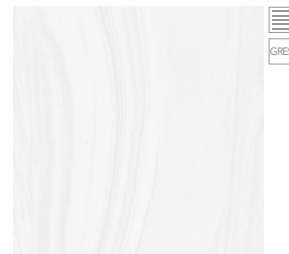

Royal Perla
33x33 cm

M072

RED BODY



| Santri Beige 30x60 cm | Decorado Santri Arena 30x60 cm |

SANTRI

30x60 cm / 11.8"x23.6"



Santri Beige
30x60cm

T004



Santri Gris
30x60cm

T004



Decorado Santri Arena
30x60cm

T005



Decorado Santri Silver
30x60cm

T005



Portland Beige
50x50 cm

M085



Portland Gris
50x50 cm

M085



RED BODY



| Carpi Beige 20x50 cm | Carpi Ocre 20x50 cm | Carpi Azul 20x60 cm | Carpi Dune Terra 20x50 cm |

CARPI

20x50 cm / 7,9"x19,7"

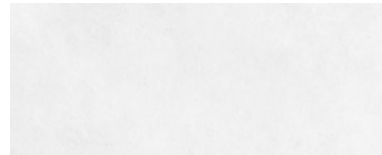

Carpi Gris
20x50 cm

M078



Carpi Beige
20x50 cm

M078



Decorado Carpi Gris
20x50 cm

M015



Decorado Carpi Beige
20x50 cm

M015

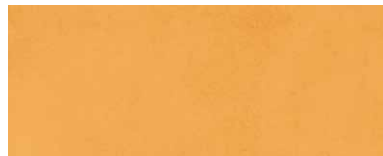

Carpi Ocre
20x50 cm

M015



Carpi Terra
20x50 cm

M015



Carpi Verde
20x50 cm

M015



Carpi Navy
20x50 cm

M015



Carpi Dune Ocre
20x50 cm

M015



Carpi Dune Terra
20x50 cm

M015



Carpi Dune Verde
20x50 cm

M015



Carpi Dune Navy
20x50 cm

M015

RED BODY



| Sugar Negro 20x50 cm | Sugar Blanco 20x50 cm | Dune Negro 20x50 cm | Dune Blanco 20x50 cm |

DAY & NIGHT - SUITE / STAR

20x50 cm / 7,9"x19,7"

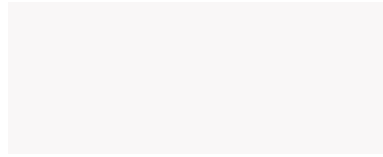

Blanco Liso
20x50 cm

M078



Suite Blanco
20x50 cm

M078



Star Blanco
20x50 cm

M015

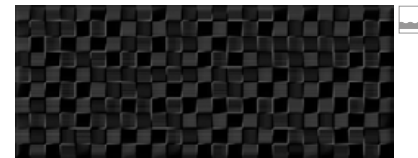

Star Negro
20x50 cm

M015



Basic Blanco
33x33 cm

M072



DAY & NIGHT - SUGAR / DUNE

20x50 cm / 7,9"x19,7"

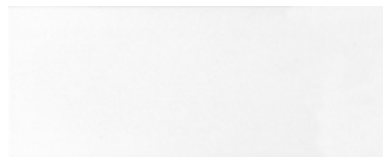

Sugar Blanco
20x50 cm

M015

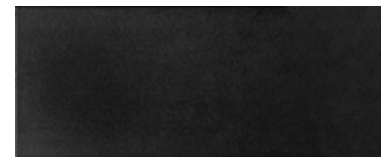

Sugar Negro
20x50 cm

M015



Dune Blanco
20x50 cm

M015

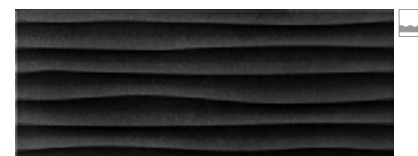

Dune Negro
20x50 cm

M015



Basic Blanco
33x33 cm

M072



RED BODY



| Land Gris 20x50 cm | Decorado Hidra Gris 20x50 cm | Portland Gris 50x50 cm |

LAND

20x50 cm / 7,9"x19,7"



Land Beige
20x50 cm

M078

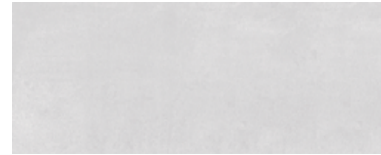

Land Gris
20x50 cm

M078



Decorado Hidra Beige
20x50 cm

M015



Land Noce
20x50 cm

M078



Land Acero
20x50 cm

M078



Decorado Hidra Gris
20x50 cm

M015



Decorado Brick Beige
20x50 cm

M015

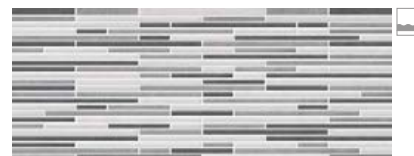

Decorado Brick Gris
20x50 cm

M015



Decorado Hidra Azul
20x50 cm

M015

RED BODY



| Natura Gris 20x50 cm | Natura Azul 20x50 cm |

NATURA

20x50 cm / 7,9"x19,7"



Natura Beige
20x50 cm

M078



Natura Marrón
20x50 cm

M078



Natura Gris
20x50 cm

M078



Natura Azul
20x50 cm

M078



Decorado Brick Beige
20x50 cm

M015

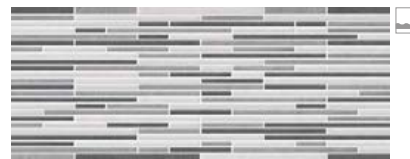

Decorado Brick Gris
20x50 cm

M015



Portland Beige
50x50 cm

M085



Portland Noce
50x50 cm

M085



Portland Gris
50x50 cm

M085



Portland Acero
50x50 cm

M085



Portland Antracita
50x50 cm

M085

RED BODY



| Personality Beige 20x50 cm | Decorado Cube Beige 20x50 cm |

PERSONALITY

20x50 cm / 7,9"x19,7"



Personality Beige
20x50 cm

M078



Personality Gris
20x50 cm

M078



Personality Cuero
20x50 cm

M078



Personality Acero
20x50 cm

M078



Decorado Cube Beige
20x50 cm

M015



Decorado Cube Gris
20x50 cm

M015

RED BODY



| Sintra Beige 20x50 cm | Sintra Adoc Beige 20x50 cm |

SINTRA

20x50 cm / 7,9"x19,7"



Sintra Beige
20x50 cm

M078



Sintra Noce
20x50 cm

M078



Sintra Gris
20x50 cm

M078



Sintra Marengo
20x50 cm

M078



Sintra Adoc Beige
20x50 cm

M015



Decorado Brick Beige
20x50 cm

M015

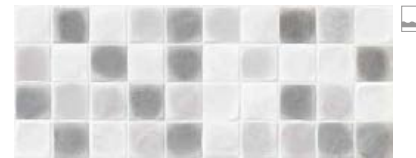

Sintra Adoc Gris
20x50 cm

M015



Decorado Brick Gris
20x50 cm

M015



Decorado Sintra Arena
20x50 cm

M015



Decorado Sintra Silver
20x50 cm

M015

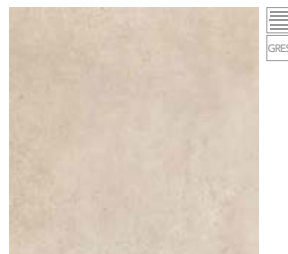

Sintra Arena
33x33 cm

M072



Sintra Silver
33x33 cm

M072



Sintra Marengo
33x33 cm

M072



VERNAZZA

20x50 cm / 7,9"x19,7"



Vernazza Blanco
20x50 cm

M078



Vernazza Negro
20x50 cm

M015



Vernazza Ona Blanco
20x50 cm

M015



Vernazza Regio
20x50 cm

M015

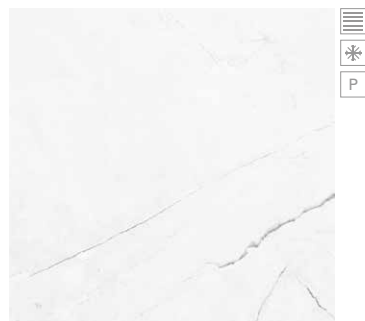

Vernazza Blanco
45x45 cm

A033



Vernazza Negro
45x45 cm

A033

• ICONOGRAFÍA •

TIPO DE SUPERFICIE TYPE OF SURFACE	PAVIMENTO FLOOR TILE	REVESTIMIENTO WALL TILE	POLIVALENTE FLOOR & WALL TILE			
ACABADOS FINISHES	BRILLO SHINE	MATE MATT	BRILLO GRANILLA GRANILLE SHINE			
MATERIAL MATERIAL	PORCELÁNICO PORCELÁNICO	MASA COLOREADA COLORED BODY	GRES	PASTA BLANCA WHITE BODY	PASTA ROJA RED BODY	
CARACTERÍSTICAS TÉCNICAS TECHNICAL CHARACTERISTICS	ANTIHIELO ANTI FROST	ANTIDESLIZANTE ANTISLIP	RECTIFICADO RECTIFIED	RELIEVE RELIEF	DESTONIFICACIÓN SHADE VARIATION	V2 VARIACIÓN LIGERA. SLIGHT VARIATION.
					COLOCACIÓN TILE-LAYING	V3 VARIACIÓN MODERADA. MODERATE VARIATION.
						V4 VARIACIÓN SUBSTANCIAL. SUBSTANTIAL VARIATION.
						TRABADO MENOR A 20%
						JUNTA 3mm JOINT 3mm

• DESTONIFICADO •

Los azulejos pueden variar en color, textura o apariencia según el diseño del fabricante para una serie en particular. La siguiente tabla muestra la clasificación estética para que el fabricante pueda comunicar las características de un producto en concreto. Cualquier pregunta o duda sobre su elección de azulejos debe ser aclarada antes de su instalación.

V2-VARIACIÓN LIGERA.

Las diferencias en textura y/o dibujos con colores son claramente diferenciadas.

V3-VARIACIÓN MODERADA.

Mientras que los colores y/o texturas presentes en una sola pieza serán indicativos de los colores y/o texturas en el resto de piezas, la cantidad de colores y/o texturas en cada pieza pueden variar significativamente. Es recomendable que se muestre toda la gama de colores antes de elegir.

V4-VARIACIÓN SUBSTANCIAL.

Color aleatorio y/o diferencia en textura de una pieza a otra, hasta el punto que una puede tener un color y/o textura diferentes al resto de piezas. Además, la instalación final será única. Se recomienda que se muestre toda la gama antes de elegir.

Tiles may vary in color, texture, or appearance according to the manufacturer's design for that particular tile series of produce line. The following aesthetic class designations have been provided in the Table, so that manufacturer may communicate the aesthetic characteristics of a particular tile product. Any questions or concerns about your tile selection should be clarified prior to installation.

V2- SLIGHT VARIATION.

Clearly distinguishable differences in texture and/or pattern with similar colors.

V3-MODERATE VARIATION.

While the colors and/or texture present on a single piece of tile will be indicative of the colors and/or texture to be expected on the other tiles, the amount of color and/or texture on each piece may vary significantly. It is recommended that the range be viewed before selection.

V4-SUBSTANTIAL VARIATION

Random color and/or texture differences from tile, so that one tile may have totally different color and/or texture from that one other tiles. Thus, the final installation will be unique. It is recommended that range be viewed before selection.



◆ PACKING ◆

PORCELÁNICO

Formato / size	PZ/CJ	M ² /BOX	KG/CJ	PALET	CJ/PALET	M ² /PALET	KG/PALLET
Size	PC/BOX	M ² /BOX	KG/CJ	PALLET	BOX/PALLET	M ² /PALLET	KG/PALLET
100x100 MODULA	8	1,00	21,53	108x108	44	44,00	959
				80x120 Europallet	34	34,00	754
80x80	2	1,28	29,71	93x113	40	51,20	1203
				80x120 Europallet	35	44,80	1062
75x75	2	1,25	29,92	-	-	-	-
				80x120 Europallet	40	45	1121
50x100	3	1,50	33,20	120x108	32	48,00	1080
				80x120 Europallet	24	36,00	820
50x50	6	1,50	32,40	95x95	48	72,00	1560
				80x120 Europallet	24	36,00	805
33x67	6	1,33	29,10	108x108	48	63,84	1409
				80x120 Europallet	40	53,20	1192
33x67 REDSTONE , POTES	7	1,55	30,10	110x110	48	74,40	1458
33x33	14	1,55	28,00	100x100	44	68,20	1244
				80x120 Europallet	42	65,10	1177
33x33 SLIM	16	1,77	26,55	100x100	44	77,88	1180
23x100	6	1,42	27,59	108x120	54	76,68	1504
				80x120 Europallet	24	34,08	670
23x100R	6	1,38	27,59	108x120	54	74,52	1400
				-	-	-	-
23x46	14	1,45	26,58	108x108	48	69,60	1294
				80x120 Europallet	36	52,20	979
8x67	17	0,91	18,70	100x100	48	43,68	909
				-	-	-	-

GRES

Formato	PZ/CJ	M ² /BOX	KG/CJ	PALET	CJ/PALET	M ² /PALET	KG/PALLET
Size	PC/BOX	M ² /BOX	KG/CJ	PALLET	BOX/PALLET	M ² /PALLET	KG/PALLET
33x33	14	1,55	28,2	100x100	44	68,20	1252
				80x120 Europallet	42	65,10	1196

REVESTIMIENTO / WALL TILES

Formato / size	PZ/CJ	M ² /BOX	KG/CJ	PALET	CJ/PALET	M ² /PALET	KG/PALLET
Size	PC/BOX	M ² /BOX	KG/CJ	PALLET	BOX/PALLET	M ² /PALLET	KG/PALLET
40x120	3	1,44	28,00	-	-	-	-
				80x120 Europallet	20,00	28,80	580,80
30x90	5	1,35	25,12	120x95	54	72,90	1374
				80x120 Europallet	24	32,40	625
30x60	8	1,44	26,12	103x103	48	69,12	1266
				80x120 Europallet	32	46,10	870
25x75	8	1,50	27,19	108x108	48	72,00	1323
				80x120 Europallet	36	54,00	1001
20x50	10	1,00	16,40	108x108	80	80,00	1324
				80x120 Europallet	70	70,00	1160

PIEZAS ESPECIALES / ESPECIAL PIECES

Formato	PIEZA	PC/CJ
Size	PIECE	PC/BOX
30x60	DECORADO FUSION	6
30x30 (5x5)	MOSAICOS*	12
20x25	DECORADO SEC	8
1x100	LISTELO METAL	10

**RODAPIE / SKIRTING

Formato	CÓDIGO	PC/CJ
Size	CODE	PC/BOX
Rodapie 7,5x50 (23x100)	P070	16
Rodapie 7,5x50 (23x100R)	P095	16
Rodapie 8x33	P050	17
Rodapie 8x45	P065	16
Rodapie 8x50 (50x50)	P065	16
Rodapie 8x50 (50x100R)	P095	16
Rodapie 8x67	P095	17
Rodapie 8x75	P135	16
Rodapie 8x80	P135	16
Rodapie 8x100	P135	16

* Mosaicos 30x30 (5x5) cm disponibles en todos los productos bajo petición.
Mosaics 30x30 (5x5) cm available to all the products on demand.

** Rodapie disponibles en todos los productos bajo petición.
Skirting available to all the products on demand.

• DIFERENTES COLOCACIONES DE LA SERIE MODULA •



Modulo 1 Modula Abadía Centeno



Modulo 2 Modula Abadía Centeno



Modulo 3 Modula Abadía Centeno



Modulo 4 Modula Abadía Centeno



Modulo 5 Modula Abadía Centeno



Modulo 6 Modula Abadía Centeno



Modulo 7 Modula Abadía Centeno

PIEZAS ESPECIALES

PELDAÑO TÉCNICO

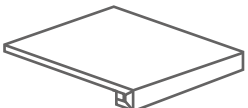
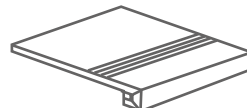
Sin ranura Doble inglete	Con ranura Doble inglete	FORMATO	CÓDIGO
		80x80 cm	P705
		75x75 cm	P655
		50x100 cm	P725
		50x50 cm	P545
		33x67P	P600
		33x33P cm	P415
		33x33 cm	P400
		23x100 cm (1ingletes)	P675
		23x100 cm (2ingletes)	P705
		23x100R cm (1ingletes)	P695
23x100 cm (2ingletes)	P710		

PELDAÑO RECTO EXTRUSIONADO

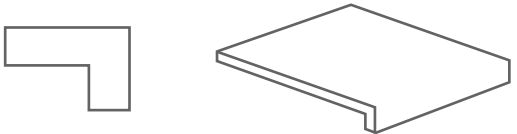

FORMATO	CÓDIGO
33x33 cm	P260

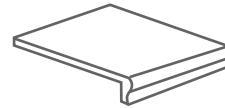
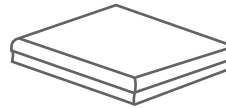

PELDAÑO TORELO

Peldaño torelo	Peldaño torelo angular	FORMATO	PELDAÑO TORELO	PELDAÑO TORELO ANGULAR
		50x50 cm	P320	-
		33x33 cm	P245	P300

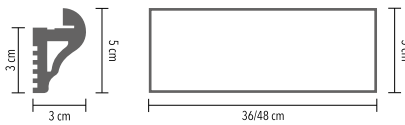
Pegado de un torelo, en la base seleccionada de un proveedor externo y una paleta de colores limitada. El color del torelo pegado no tiene porque ser exacto al color de la base. Intentamos seleccionar el tono más acorde al tono general de la base.

PELDAÑO TORELO. Totalmente apoyado en la rista del soporte.
TORELO STEP. Completely leaning in the edge of the support.

Lecho continuo de mortero adhesivo.
Continuous layer set mortar.

Tabica/Tile

- Colocar el torelo totalmente apoyado en el soporte de la escalera, de modo que tanto la huella como la moldura queden totalmente adheridas y no trabajen en falso.
- En caso necesario cortar el peldaño a la medida de la huella.
- Utilizar el mortero adhesivo o cemento cola de buena calidad, en capa continua y bien macizado, evitando que queden huellas.
- Completar la colocación de la tabica cuando el peldaño este suficientemente firme.

- Place the torelo-step leaning on the stair support, in order the moulding and tread to be perfectly fixed.
- If necessary cut the step to the tread-size.
- Use on thin set mortar or latex cement mortar, in continuous layer and well filled up, avoiding empty hollows.
- Complete the décor tile inspiration when the step is stable enough.

INSTRUCCIONES PARA LA COLOCACIÓN Y MANTENIMIENTO

Asegurarse que el soporte estructural esté enrasado y preparado (limpio de polvo, aceites...)

El sentido de colocación será desde abajo hacia arriba (sentido ascendente) (1)

Utilizar herramientas de colocación adecuadas, así como adhesivos específicos para la baldosa y soporte implicados

Manipular con cuidado

Colocar todas las huellas, dejando la colocación de las contrahuellas para el final (1)

La contrahuella debe apoyar sobre la pieza base (primer escalón) o sobre la huella (sucesivos peldaños) (2)

Maestrear la verticalidad sobre la que se coloca la contrahuella hasta el nivel que nos permita, una vez completado el fraguado, colocando en capa fina, llegar al límite exterior de la huella o a la distancia específica para dejar la diferencia de profundidad deseada entre huella y contrahuella. Según el Código Técnico de la Edificación, para escaleras previstas para evacuación ascendente, o las utilizadas preferentemente por niños, ancianos o personas con discapacidad, no se permite bocel ni resalte (huella y contrahuella deben quedar perfectamente alineados), para evitar tropiezos y caídas (3)

Cortar la contrahuella a la medida establecida para cumplir con el dimensionamiento inicial de la escalera (el Código Técnico de la Edificación establece que para escaleras de uso general, la altura del peldaño debe ser inferior a 18,5 cm y superior a 13 cm, además, la superficie pisable (huella) debe ser superior a 28 cm (4)

Las baldosas deben quedar perfectamente macizadas, sin huecos, para evitar potenciales fuentes de roturas ó despegues (2)

Se debe proceder al rejuntado entre las distintas piezas.

Proteger el material ya colocado hasta que finalice la obra, con el fin de evitar daños sobre la superficie cerámica durante los trabajos posteriores.

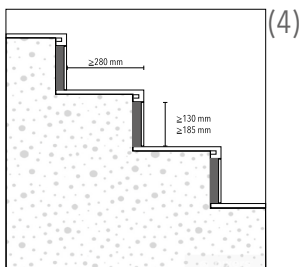
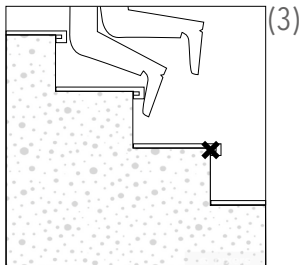
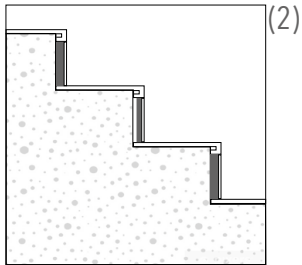
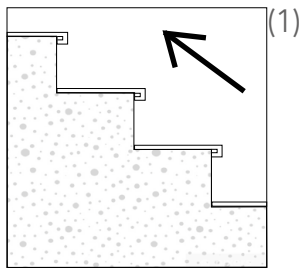

INSTRUCTIONS FOR INSTALLATION & CARE

Make sure that the substrate is flat and ready for laying the treads (with no dust, oil or grease etc).

Start to lay the treads from the bottom of the staircase (moving upwards). (1)

Use suitable tile-laying tools and the right adhesive for the tiles and substrate.

Handle with care.

Lay all the stair treads before proceeding to lay the risers. (1)

The stair riser of the first step should rest on the bottom floor tile. Subsequent risers should rest on the stair tread below each one. (2)

Level the vertical substrate for each stair riser so that, once the cement has set and the stair riser has been laid using the thin bed method, it reaches the outer edge of the stair tread above it or leaves the desired joint between them. According to the Spanish Building Code, when stairs are used for upward evacuation or mainly used by children, the elderly or the disabled, stair nosings or overhanging treads are forbidden. (The tread and riser must be edge to edge). (3)

Cut the stair riser to the right size to comply with the initial plans for the stairs. (The Spanish Building Code establishes that stairs for general use should have steps with a height of over 13 cm and less than 18,5 cm and that the treads should be bigger than 28 cm). (4)

Bond the tiles solidly, making sure that there are no voids, to prevent them from breaking or coming loose. (2)

Grout the tiles.

Protect the tiled surfaces until all on-site work has been completed in order to prevent them from being damaged during subsequent building tasks.

♦ CARACTERÍSTICAS TÉCNICAS ♦

Series / series	Formato / size	Modelo / Model	PEI	MOHS	RESISTENCIA A LAS MANCHAS STAINS RESISTANCE	RESISTENCIA QUÍMICA CHEMICAL RESISTANCE	PENDULO PENDULUM	RAMPA RAMP	A-B-C
ABADÍA - Antislip	50x50 cm	Avena, Centeno	IV	5	5	GA-GLA-GHA	C3	R11	-
ABADÍA	50x50 cm	Avena, Centeno	IV	5	5	GA-GLA-GHA	-	-	-
AKELARRE	23x100 cm	Beige, Gris	IV	6	5	GA-GLA-GHA	-	-	-
AKELARRE	23x100 cm	Acero, Noce	III	6	5	GA-GLA-GHA	-	-	-
AMALFI	50x100 cm, 33x67 cm	Beige, Gris, Taupe, Decorados	IV	6	5	GA-GLA-GHA	-	-	-
AMALFI - Antislip	50x100 cm	Beige, Gris, Taupe,	IV	6	5	GA-GLA-GHA	C3	R11	-
ARDENZA	80x80 cm	Brillo	III	4	5	GA-GLA-GHA	-	-	-
ARDENZA	80x80 cm	Mate	III	5	5	GA-GLA-GHA	-	-	-
ARDENZA	33x67 cm	Gold, Mix	IV	6	5	GA-GLA-GHA	-	-	-
ARES	33x33 cm	Acero, Cotto	III	6	5	GA-GLA-GHA	C3	R11	-
ARES	33x33 cm	Beige	IV	6	5	GA-GLA-GHA	C3	R11	-
BACKWOOD	8x67 cm	-	III	6	5	GA-GLA-GHA	-	-	-
BANAK	23x100 cm	Beige, Blanco, Gris	IV	6	5	GA-GLA-GHA	-	-	-
BANAK - Antislip	23x100 cm	Beige, Blanco, Gris	IV	6	5	GA-GLA-GHA	C3	R11	-
BASIC	33x33 cm	Blanco	IV	6	5	GA-GLA-GHA	-	-	-
BIERZO	33x67 cm	Mix, Negro	6	IV	GA	GA-GLA-GHA	-	-	-
BIERZO - Antislip	33x67 cm	Mix, Negro	6	IV	GA	GA-GLA-GHA	C3	R11	-
BLUESTONE	50x50cm,33x67 cm	Negro	III	6	5	GA-GLA-GHA	-	-	-
BONN	80x80 cm	Acero, Beige, Gris	IV	7	5	GA-GLA-GHA	-	-	-
CANADA	80x80 cm	Roble	III	7	5	GA-GLA-GHA	-	-	-
CARTAGO	45x45 cm	Beige, Gris	IV	6	5	GA-GLA-GHA	-	-	-
COTTO	80x80 cm	Acero, Cuero	III	7	5	GA-GLA-GHA	-	-	-
COTTO	80x80 cm	Beige, Gris	IV	7	5	GA-GLA-GHA	-	-	-
COTTO - Antislip	80x80 cm	Beige, Gris	IV	7	5	GA-GLA-GHA	C3	R11	-
DAFNE	80x80 cm	Beige, Gris	IV	7	5	GA-GLA-GHA	-	R10	-
DAFNE	80x80 cm	Negro, Taupe	III	7	5	GA-GLA-GHA	-	R10	-
DOVER	50x100 cm	Acero, Beige, Gris, Negro	III	5	5	GA-GLA-GHA	-	-	-
DOVER - Antislip	50x100 cm	Gris	III	5	5	GA-GLA-GHA	C3	R11	-
GREDOS	33x33 cm	Avena, Maiz	IV	7	5	GA-GLA-GHA	-	-	-
GREDOS - Antislip	33x33 cm	Avena, Maiz	IV	8	5	GA-GLA-GHA	C3	-	-
GUDAR	33x33 - SLIM cm	Avena	IV	7	5	GA-GLA-GHA	C3	R11	-
GUDAR	33x33 - SLIM cm	Centeno	III	7	5	GA-GLA-GHA	C3	R11	-
FERRARA	50x100 cm, 33x67 cm	Acero	III	7	5	GA-GLA-GHA	-	-	-
FERRARA	50x100 cm, 33x67 cm	Beige, Gris	IV	7	5	GA-GLA-GHA	-	-	-
FERRARA - Antislip	50x100 cm, 33x67 cm	Acero	III	7	5	GA-GLA-GHA	C3	R11	-
FERRARA - Antislip	50x100 cm, 33x67 cm	Beige, Gris	IV	7	5	GA-GLA-GHA	C3	R11	-
HALIFAX	80x80 cm	-	III	6	5	GA-GLA-GHA	-	-	-
HAT	80x80 cm, 60x60 cm, 59,6x59,6 cm	Blanco	IV	7	5	GA-GLA-GHA	-	-	-
HAYEDO	23x100 cm	Roble	III	5	5	GA-GLA-GHA	-	-	-
HAYEDO - Antislip	23x100 cm	Roble	III	6	5	GA-GLA-GHA	C3	R11	-
HAYEDO	23x100 cm	Almond, Gris	IV	5	5	GA-GLA-GHA	-	-	-
HAYEDO - Antislip	23x100 cm	Almond, Gris	IV	6	5	GA-GLA-GHA	C3	R11	-
LONDON	80x80 cm	Acero	III	7	5	GA-GLA-GHA	-	R10	-
LONDON	80x80 cm	Beige, Gris	IV	7	5	GA-GLA-GHA	-	R10	-
MARMI	50x100 cm	Bianco	III	5	5	GA-GLA-GHA	-	-	-

Series / series	Formato / size	Modelo / Model	PEI	MOHS	RESISTENCIA A LAS MANCHAS STAINS RESISTANCE	RESISTENCIA QUÍMICA CHEMICAL RESISTANCE	PENDULO PENDULUM	RAMPA RAMP	A-B-C
MARMI	33x33 cm	Bianco	IV	5	5	GA-GLA-GHA	C2	-	-
MODULA BIERZO	100x100 cm	Mix	IV	6	5	GA-GLA-GHA	-	-	-
MODULA BIERZO · Antislip	100x100 cm	Mix	IV	6	5	GA-GLA-GHA	C3	R11	-
MODULA ABADÍA	100x100 cm	Avena, Centeno	IV	5	5	GA-GLA-GHA	-	-	-
MODULA ABADÍA · Antislip	100x100 cm	Avena, Centeno	IV	5	5	GA-GLA-GHA	C3	R11	-
MODULA AUGUSTA	100x100 cm	Beige	IV	5	5	GA-GLA-GHA	-	-	-
MODULA AUGUSTA · Antislip	100x100 cm	Beige	IV	5	5	GA-GLA-GHA	C3	R11	-
MODULA PORTOBELLO	100x100 cm	Ivory, Silver, Taupe	IV	7	5	GA-GLA-GHA	-	-	-
MODULA PORTOBELLO · Antislip	100x100 cm	Ivory, Silver, Taupe	IV	7	5	GA-GLA-GHA	C3	R11	-
MURTA	33x33 · SLIM cm	Avena	IV	7	5	GA-GLA-GHA	C3	R11	-
MURTA	33x33 · SLIM cm	Centeno	III	7	5	GA-GLA-GHA	C3	R11	-
NATURA	33x33 cm	Azul, Marrón	III	5	5	GA-GLA-GHA	-	-	-
NATURA	33x33 cm	Beige, Gris	IV	5	5	GA-GLA-GHA	-	-	-
NEW YORK · Antislip	33x33 cm	Beige, Musgo, Teja	IV	7	5	GA-GLA-GHA	C3	-	-
NUBA	50x100 cm, 33x67 cm	Blanco	III	5	5	GA-GLA-GHA	-	-	-
OXFORD	8x67 cm	-	III	6	5	GA-GLA-GHA	-	-	-
PARK	50x100 cm	Steel	III	6	5	GA-GLA-GHA	-	-	-
PARK	50x100 cm	Gold, Silver	IV	6	5	GA-GLA-GHA	-	-	-
PIEDRA	23x46 cm	Mix	III	7	5	GA-GLA-GHA	-	-	-
PIEDRA	23x46 cm	Gris, Natural	IV	7	5	GA-GLA-GHA	-	-	-
PIRINEOS	33x33 · SLIM cm	Avena	IV	7	5	GA-GLA-GHA	C3	R11	-
PIRINEOS	33x33 · SLIM cm	Centeno	III	7	5	GA-GLA-GHA	C3	R11	-
PORTLAND	50x50 cm, 33x67 cm	Acero, Antracita, Noce	III	6	5	GA-GLA-GHA	-	-	-
PORTLAND	50x50 cm, 33x67 cm	Decoradoo Horizon Beige, Decorado Horizon Gris, Beige, Gris	IV	6	5	GA-GLA-GHA	-	-	-
PORTOBELLO	50x100 cm, 50x50 cm, 33x67 cm	Ivory, Silver, Taupe	IV	7	5	GA-GLA-GHA	-	-	-
PORTOBELLO · Antislip	50x100 cm, 50x50 cm, 33x67 cm	Ivory, Silver, Taupe	IV	7	5	GA-GLA-GHA	C3	R11	C
POTES	33x33 cm	Cuero, Negro	III	-	5	GA-GLA-GHA	C3	-	-
POTES	33x33 cm	Acero, Ivory, Taupe	IV	-	5	GA-GLA-GHA	C3	-	-
QUEBEC	80x80 cm	Blanco	III	4	5	GA-GLA-GHA	-	-	-
REDSTONE	33x33 cm	Acero, Crema	III	7	5	GA-GLA-GHA	C3	-	-
REDSTONE	33x33 cm	Beige, Gris	IV	7	5	GA-GLA-GHA	C3	-	-
REDSTONE · Antislip	30x60 cm	Acero, Crema, Beige, Gris	III	7	5	GA-GLA-GHA	C3	R11	-
REGINA	80x80 cm		IV	5	5	GA-GLA-GHA	-	-	-
ROCK	23x46 cm	Beige, Cuero, Gris	IV	6	5	GA-GLA-GHA	-	-	-
RONDA	33x33 cm	Cuero	III	5	5	GA-GLA-GHA	-	-	-
RONDA	33x33 cm	Beige	IV	5	5	GA-GLA-GHA	-	-	-
SIA	23x100 cm	Almond, Blanco, Miel	IV	5	5	GA-GLA-GHA	-	-	-
SIA	23x100 cm	Oliva	III	5	5	GA-GLA-GHA	-	-	-
STRATA	33x67 cm	Silver	III	7	5	GA-GLA-GHA	-	-	-
STRATA	33x67 cm	Beige, Blanco, Gris	IV	7	5	GA-GLA-GHA	-	-	-
SUNROCK	33x67 cm	Negro	III	6	5	GA-GLA-GHA	-	-	-
SUNROCK	33x67 cm	Blanco	IV	6	5	GA-GLA-GHA	-	-	-
TRIBECA	23x100 cm	-	IV	6	5	GA-GLA-GHA	-	-	-
URBAN	75x75 cm	Acero, Perla	IV	6	5	GA-GLA-GHA	-	-	-
URBAN · Antislip	75x75 cm	Acero, Perla	IV	6	5	GA-GLA-GHA	C3	R11	-
VERNAZZA	45x45 cm	Blanco	IV	6	5	GA-GLA-GHA	-	-	-
VERNAZZA	80x80 cm, 45x45 cm	Negro	III	6	5	GA-GLA-GHA	-	-	-

♦ ANTIDESLIZANTE ♦

Con el fin de dar una mayor seguridad en aquellas áreas transitables, cuyas condiciones de humedad y pendientes son mayores de lo habitual.

Los productos marcados con nuestra simbología ANTI-SLIP, han sido sometidos a las pruebas de ensayo según las normas UNE-ENV 12633:2003, DIN-51130, DIN-51097 y/o BS 7976-2.

Para más información, consultar con nuestro dpto. técnico.

The aim here is to provide better safety areas of pedestrian traffic, where the humidity conditions and slopes are greater than normal.

This series rates higher than the test results recommended by Regulation UNE-ENV 12633:2003, DIN-51130, DIN-51097 and/or BS 7976-2 .

For more information on this, contact our Technical Department.

DIN 51130	PLANO INCLINADO, PIES CALZADOS INCLINED PLANE, WEARING SHOES
-----------	---

Clasificación de la media corregida conjunta del ángulo crítico para la clasificación antideslizante.
Classification joint adjusted average of critical angle for slip classification.

Clase antideslizante Slip Class	Adherencia Adherence	Ángulo inclinación Slope angle
R9	Normal Normal	De 6° a 10°
R10	Media Medium	> 10° a 19°
R11	Alta High	> 19° a 27°
R12	Fuerte Strong	> 27° a 35°
R13	Muy fuerte Very strong	>35°

CTE	CÓDIGO TÉCNICO DE LA EDIFICACIÓN, SECCIÓN DB-SUA1 VERSIÓN DICIEMBRE 2014
-----	--

CLASE CLASS	Rd	RESISTENCIA AL DESPLAZAMIENTO DISPLACEMENT RESISTANCE
1	15 < Rd ≤ 35	Zonas interiores secas, pendiente <6%. Interior areas that are dry with a grade of <6%.
2	35 < Rd ≤ 45	Zonas interiores secas, pendiente >6%. Zonas interiores húmedas, terrazas, cubiertas, vestuarios duchas, aseos, cocinas etc. Interior areas that are dry with a grade of >6% Interior wet areas, covered terraces, showers, bathroom floor, kitchens, etc.
3	> 45	Zonas con agua, grasas, lubricantes, etc. Zonas interiores húmedas con pendiente > 6%. Zonas exteriores, piscinas. Wet/greasy/lubricated environments. Interior wet areas with a grade of >6%. Exterior areas, swimming pools.

CLASE EXIGIBLE A LOS SUELOS EN FUNCIÓN DE SU LOCALIZACIÓN RATING REQUIRED FOR FLOORING DEPENDING ON ITS LOCATION

LOCALIZACIÓN Y CARACTERÍSTICAS DE SUELO LOCATION AND CHARACTERISTICS OF THE FLOOR	CLASE CLASS
ZONAS INTERIORES SECAS Superficies con pendiente menor que el 6% Superficies con pendiente mayor que el 6% y escaleras DRY INDOOR AREAS Surfaces with a slope of less than 6% Surfaces with a slope equal to or higher than 6% and stairs	1 2
ZONAS INTERIORES HÚMEDAS, TALES COMO LAS ENTRADAS A LOS EDIFICIOS DESDE EL ESPACIO EXTERIOR (1), TERRAZAS CUBIERTAS, VESTUARIOS, BAÑOS, ASEOS, COCINAS, ETC. : Superficies con pendiente menor que el 6% Superficies con pendiente igual o mayor que el 6% y escaleras INDOOR AREAS SUBJECT TO MOISTURE, SUCH AS ENTRANCES TO BUILDINGS FROM OUTDOOR AREAS (1), COVERED TERRACES AND BALCONIES, CHANGING ROOMS, BATHROOMS, CLOAKROOMS, KITCHENS ETC: Surfaces with a slope of less than 6% Surfaces with a slope equal to or higher than 6% and stairs	2 3 2 3
ZONAS EXTERIORES. PISCINAS. DUCHAS (2) OUTDOOR AREAS. SWIMMING POOLS. SHOWERS (2)	3 3

(1) Excepto cuando se trate de accesos directos a zonas de uso restringido

(2) En zonas previstas para usuarios descalzos y en el fondo de los vasos, en las zonas en las que la profundidad no exceda de 1.50 m.

Dicha clase se mantendrá durante la vida útil del pavimento

(1) Except for accesses that lead directly to areas of restricted use

(2) In places where users are expected to go barefoot and in the bottom of swimming pools in areas with a depth of less than 1.50 m.

This rating is maintained throughout the useful life of the flooring.

TABLA DE VALORACIÓN DE RIESGO DE DESLIZAMIENTO
SLIP RISK ASSESSMENT TABLE

Locales y áreas de trabajo Remises work areas	VALOR ORIENTATIVO APPROXIMATE VALUE	
Entradas y zonas de acceso, incluyendo hoteles, oficinas, edificios públicos, centros comerciales, tiendas, escuelas y guarderías, zonas comunes de edificios públicos, vestíbulos de ascensores internos Entries and access areas including hotels, offices, public buildings, shopping centres, shops, schools and kindergartens, common areas of public buildings, internal lift lobbies	Wet area(1)	R10
	Transitional area	R9
	Dry area	R8 ⁽²⁾
Rampas internas, pendientes (mayores de 1 en 20) - Secas Internal ramps, slopes (greater than 1 in 20) - Dry		R10
Instalaciones totales en oficinas, hoteles, centros comerciales Total facilities in offices, hotels, shopping centres		R10
Puntos de venta de comida rápida, zonas de mostrador de buffet, zona de restauración y zonas de comida rápida en centros comerciales Fast food outlets, buffet food server areas, food court and fast food dining areas in shopping centres		R10
Explanadas cubiertas en estadios deportivos Undercover concourse areas of sports stadium		R10
Balcones privados, no accesibles al público Private, publicly inaccessible balconies		R10
Zonas donde uno mismo se encarga de preparar la comida o pequeñas cocinas Self catering areas or kitchenettes		R10
Zonas de frutas y verduras frescas en tiendas y supermercados Shop and supermarket fresh fruit and vegetable areas		R10
Pasillos de supermercado excepto las zonas de comida fresca Supermarket aisles except fresh fruit areas		R9
Garajes residenciales Residential garages		R10
Cocinas residenciales Residential kitchens		R9
Baños residenciales, baños incorporados, aseos y lavanderías Residential bathrooms, ensuites, toilets and laundries		R9 o A
Hoteles, hospitales e instalaciones para el cuidado de mayores Hotels, hospitals and aged care facilities	Salas y pasillos Wards and corridors	R9
	Con baño incorporado Ensuites	R10 o A
Vuelos de peldaños internos accesibles - con presencia de pasamanos Accessible internal stair nosings - Handrails present	Seco Dry	R10
	Húmedo Wet	R11 o B
Columnatas externas, pasarelas, cruces de peatones, balcones, verandas, cocheras, entradas de coches, patios, forjados de techos, aparcamientos públicos, patios de escuela, zonas de venta externas (por ejemplo, mercados). External colonnade, walkways, pedestrian crossings, balconies, verandas, carports, driveways, court yards and roof decks, public car parks, school yards, external sales areas (e.g. markets).		R11
Caminos privados, accesos primarios al local o edificio, vuelos de peldaños externos Private paths, primary access to premises, external stair nosings		R11
Zonas de servir detrás de las barras de clubes y hoteles públicos, cámaras frigoríficas, congeladores Serving areas behind bars in public hotels and clubs, cold stores, freezers		R11
Rampas externas (incluyendo las entradas de coches, aceras, etc., con -pendiente). Pendiente desde 1 en 20 hasta 1 en 14 External ramps (including sloping driveways, footpaths, etc.); slope of 1 in 20 to 1 in 14		R11



Locales y áreas de trabajo Remises work areas	VALOR ORIENTATIVO APPROXIMATE VALUE
Rampas externas (incluyendo las entradas de coches, aceras, etc., con pendiente). Pendiente con una inclinación mayor de 1 en 14 External ramps (including sloping driveways, footpaths, etc.); slope steeper than 1 in 14	R11
Muelles de carga Loading docks	R11
Cocinas comerciales Commercial kitchens	R11
Vestidores comunitarios Communal changing rooms	A
Playas de piscina y duchas comunitarias Swimming pool surrounds and communal shower rooms	B
Rampas de piscina y escaleras que llevan al agua Swimming pool ramps and stairs leading into water	C

1. Definiciones:
a) Zonas secas - Aquellas zonas en las que las medidas de control apropiadas aseguran que una zona permanezca seca y limpia cuando se usa.
b) Zonas de transición - Aquellas zonas que deben mantenerse secas, por ejemplo mediante la provisión de elementos de diseño (marquesinas, sumideros, esteras, cámaras estancas, etc.) apropiados para la localización física, clima y exposición al agua en general, de acuerdo con su mantenimiento en una condición seca y limpia por el responsable de las instalaciones.
c) Zona húmedas - Aquellas zonas que no se definen como secas o zonas de transición, que pueden estar mojadas, de forma constante o intermitente, o contaminadas de otra forma.
2. La clase R8 es una clasificación artificial que se ha utilizada para indicar productos que no obtienen la clase R9.

1. Definitions:
a) Dry areas – those areas in which appropriate control measures ensure an area remains dry and clean when in use.
b) Transitional areas – those areas that are intended to be kept dry such as by the provision of design features (awnings, drains, mats, air locks, etc.) appropriate to the physical location, climate and general exposure to water, as maintained in a dry and clean condition by the facilities manager.
c) Wet areas – those areas that are not defined as a dry or transitional area, which may be either constantly or intermittently wet or otherwise contaminated.
2. R8 is an artificial classification that has been used to indicate products that fail to obtain class R9.

GUV-I 8527 | PLANO INCLINADO, PIES CALZADOS / INCLINED PLANE, WEARING SHOES

CLASIFICACIÓN DE LOS RESULTADOS DEL ENSAYO DE LA RAMPA EN MOJADO, DE ANDAR DESCALZO
CLASSIFICATION OF THE RESULTS OF THE TEST OF THE WET RAMP, OF WALKING WITHOUT FOOT

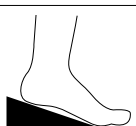
Grupo Group	Ángulo de inclinación mínimo Minimum slope angle	Zonas Zones
A	$\geq 12^\circ$ 	<ul style="list-style-type: none"> -Pasillos de andar descalzo (principalmente secos). -Vestuarios y vestidores comunitarios e individuales. -Suelos de piscinas en zonas donde no se puede nadar, si la profundidad del agua de toda la zona (de una piscina) es más de 80 cm.
B	$\geq 18^\circ$ 	<ul style="list-style-type: none"> -Pasillos de andar descalzo no clasificados en el grupo A. -Locales de duchas. -Playas de piscinas. -En las inmediaciones de las instalaciones de pulverización desinfectante. -Suelos de piscinas en las zonas donde no se puede nadar, donde la profundidad es inferior a 80cm. -Secciones donde no se puede nadar de piscinas con oleaje. -Plataformas elevadoras. -Piscinas para niños pequeños. -Escaleras que llegan al agua. -Escaleras que llegan al agua con un ancho máximo de 1 m y pasamanos en ambos lados. -Escaleras y escaleras fuera de la zona de la piscina. -Escalones y bancos para sentarse y de descanso.
C	$\geq 24^\circ$ 	<ul style="list-style-type: none"> -Escaleras que llegan al agua, si no están clasificadas en el grupo B -Piscinas para caminar. -Bordes de piscina en pendiente.

• LIMPIEZA Y MANTENIMIENTO •

RECOMENDACIONES TÉCNICAS

Para resolver las dudas que en ocasiones surgen en cuanto al mantenimiento y limpieza de materiales y a modo de recomendación, hemos creído oportuno realizar esta guía para que sirva de referencia para nuestro trabajo comercial y a ser posible ayude a resolver las dudas que puedan surgir y a la vez que satisfaga a nuestros clientes. Se controlará por parte del cliente que el material sea destinado al uso correcto. Ante cualquier duda se suspenderá la colocación y formule la consulta o reclamación correspondiente, siempre es mejor asesorarse. Un simple consejo sirve para prevenir errores y elegir mejor.

TECHNICAL RECOMMENDATIONS

In order to solve any question regarding maintenance and/or Cleaning of the goods and as a strongly recommended guidelines, so it may serve as reference to our commercial labour and also our customers would be satisfied. It will be controlled by the customer that the usage of goods will be the right one. Before any doubt, the installation will be stopped and the relative questions or claims must be placed, it is always better learn about first. A simple advice may prevent from making mistakes and will help to choose better.

LIMPIEZA Y MANTENIMIENTO

LIMPIEZA FINAL DE OBRA:

Después de la colocación es fundamental realizar una buena limpieza para eliminar residuos de junta y en general suciedad de la obra. Para esta operación recomendamos el empleo de un detergente de acción ligeramente ácida que no despidan humos tóxicos y respete las juntas, el material y el usuario, como Fila Deterdek. En el caso de material colocado con junta epoxi o en base resina, se aconseja realizar la limpieza final de obra con un limpiador específico de residuos epoxidicos, como Fila CR10.

MANTENIMIENTO:

Para un buen mantenimiento del pavimento se aconseja el empleo de un detergente neutro con alto poder limpiador como FilaCleaner. En los casos de suciedad intensa e incrustada acumulada en el tiempo, se aconseja consultar el esquema a continuación para encontrar el producto Fila ideal para cada situación.

CLEANING AND MAINTENANCE

CLEANING AFTER LAYING:

It is crucial to do a good cleaning after the tile laying with the objective to eliminate the joints residues and in general all the building dirt. For this activity we recommend the use of an action detergent with light acid that does not produce toxic fumes and respects the joints, the material and the user, like Fila Deterdek. In the case of epoxy joint or in resin base, the final cleaning is advisable to be made with a specific cleaner called Fila CR10 for epoxy residues.

REGULAR MAINTENANCE:

It is advisable to use a neutral detergent with high cleaning power like Fila Cleaner for a floor tile maintenance. In the cases of intensive and encrusted accumulated dirt it is recommendable to check the table here below to find the appropriate product Fila for each situation.

TIPO DE SUCIEDA INCRUSTADA / TYPE OF DIRTY		PRODUCTO A UTILIZAR / PRODUCTO TO USE
Cemento - Cal de agua - Rayas metales - Óxido	Cement - Calcar - Metal tracer - Rust	DETERDEK
Residuos de resina Epoxi	Epoxy residues	FILA CR10
Grasas - Bebidas - Comidas - Goma - Tintes - Rotulador - Gotas de pintura plástica	Greasy - Drinks - Food - Tire marks - Colours - Marker - Etc.	FILA PS/87
Pintadas de grafitis, spray acrílicos, alquídicos y nitro sintéticos.	Grafitis	FILA NOPAINT STAR
Cera de velas - Resinas árboles - Residuos cinta adhesiva	Wax candel - Bitument - Adhesive tape residues	FILASOLV



◆ RESERVA DE DERECHO ◆

Keros aplica una política de continuo desarrollo de sus productos y se reserva el derecho a realizar cambios en los productos, colores, especificaciones técnicas, packing y códigos sin previo aviso.

Keros ha realizado un esfuerzo considerable para que toda la información sea adecuada en el momento de la publicación de catálogo. A causa de las limitaciones del proceso de impresión los colores reproducidos pueden sufrir ligeras variaciones con respecto al producto original. Keros informa que este catálogo tiene validez a nivel informativo y por tanto no se hace responsable de los posibles errores de impresión, reservándose el derecho de realizar modificaciones sin necesidad de preaviso.

Por favor, revise el tono, el calibre y la clase antes de colocar el material. Keros no se hará responsable después de que se coloque el material.

Keros operates a policy of continuous development and reserves the right to make changes to its products, colours, engineering specifications, packaging and codes without prior notice.

Keros has taken every effort to ensure that the information contained in the catalogue is correct at the time of publication. Due to the limitations of the printing process, the colours reproduced may vary slightly from the original product. Keros advises that this catalogue is only valid for information purposes and therefore does not accept responsibility for any possible printing errors.

Please, check shade, caliber and class before placing. Keros will not take responsibility after the material is placed.

◆ CONSEJOS DE COLOCACIÓN ◆

1. PREVIO A LA COLOCACIÓN

A la recepción del producto, se deberá verificar que el producto es conforme a lo solicitado, tanto en cantidad como en calidad. Para ello verificaremos que la inscripción de las cajas corresponde con el albarán de entrega de la mercancía.

2. ADECUACIÓN DE LOS PARÁMETROS

Una vez realizada la verificación procederemos a la preparación de la superficie sobre la que se va a instalar el producto elegido.

Para lograr una buena adhesión a la superficie de colocación hay que descubrir su superficie inicial y firme, para lo cual será necesario proceder a una limpieza exhaustiva, ya que la existencia polvo y de restos de materiales condicionara la correcta adherencia del soporte con el paramento.

Los morteros cola ven reducidas sus prestaciones a partir de los 5 mm de espesor, es por ello que no permite corregir los desniveles del paramento con exceso de adhesivo, por lo que resulta esencial disponer de superficies perfectamente planas.

Para desviaciones mayores de 10 mm sería conveniente aplicar una capa de nivelación para corregirlas.

En la colocación de pavimentos en exteriores habrá que respetar las pendientes necesarias para la eliminación de las aguas.

Antes de la colocación del producto cerámico, en el caso de pavimento, es conveniente replantearnos sobre la superficie ya nivelada algunas piezas para ver el efecto que las mismas presentan.

Para colocaciones modulares, en el momento de la solicitud del pedido, se deberá informar de esta circunstancia, para la asignación de tono y calibre compatible con el modo de colocación elegido.

1. BEFORE FIXING

Upon receiving the product, the product should be checked whether it complies to the order, both in quantity and in quality. To do this, we should verify that the box registration corresponds to the delivery note of the goods.

2. ADJUSTMENT SETTINGS

Once the verification is done, we should proceed to the preparation of the surface on which the chosen product will be installed.

In order to achieve good adhesion to the laying surface the initial and firm surface should be rediscovered and a thorough cleaning is required, since the dust and the material residues will determine the proper adhesion of the support with the facing.

The tile mortars see their benefits reduced from 5 mm thickness, the reason being is that the uneven facing cannot be corrected with additional adhesive, so it is essential to have perfectly flat surfaces.

For larger deviations of 10 mm it would be advisable to apply a leveling layer to correct them.

In laying floors outdoors, the slopes should be taken into consideration for the water removal.

Before placing the ceramic product, in the case of pavement, it is recommendable to put on the leveled surface some tiles to see the produced effect.

Modular placements should be informed at the time of the order so that to provide a suitable tone and a caliber according to the chosen method of tile placing.

3.COLOCACIÓN

Dependiendo de la naturaleza del producto cerámico (porcelánico, gres o azulejo) se utilizará el tipo de colocación más adecuado.

La colocación en capa fina, es la técnica de evolución más reciente, apta para cualquier tipo de baldosa y compatible con cualquier soporte.

La colocación se realiza generalmente sobre una capa previa de regularización del paramento, ya sean enfoscados en las paredes o bases de mortero en los suelos.

Existen adhesivos adecuados para cada tipo de soporte, según la norma UNE EN 12004.

En capa fina se utilizan los adhesivos cementosos o morteros cola, las pastas adhesivas y adhesivos de resinas de reacción, con las ventajas de que el tiempo de rectificación es alto y permite una mayor deformabilidad en el soporte y mayor adherencia.

Hay que tener en cuenta que el soporte base suele ser una superficie continua sometida a las contracciones y dilataciones provocadas por los cambios térmicos, movimientos estructurales o la propia retracción del cemento. Por este motivo, una perfecta ejecución de las juntas garantiza que estos movimientos naturales del soporte base no se trasladen a la superficie embaldosada.

4. JUNTAS ESTRUCTURALES

El dimensionado de las juntas estructurales debe detallarse perfectamente en el proyecto de edificación, y deben ser fijadas por el arquitecto o técnico especializado.

Las juntas estructurales entre las baldosas deben llegar hasta el soporte, y su anchura debe ser, como mínimo, la de la junta estructural del soporte.

Las juntas estructurales se rematan llenándolas con materiales de elasticidad duradera.

5.JUNTAS PERIMETRALES

Tienen la misión de aislar el pavimento cerámico, junto con su correspondiente capa de adhesivo, de otras superficies revestidas o pavimentadas como son las uniones pared-suelo o los encuentros con otros elementos constructivos como pilares, ventanas o puertas.

Su misión es evitar que tanto el material cerámico como el adhesivo, tengan contacto con los mencionados elementos, a fin de prevenir la acumulación de tensiones.

Las juntas entre paredes y suelos son siempre necesarias para superficies superiores a 7 m². Se recomienda una anchura de junta de 5 a 10 mm, que quedará oculta por el rodapié, o por el revestimiento.

Las juntas perimetrales deben estar convenientemente ejecutadas y funcionar como tales, es decir, deben estar limpias de restos de materiales de obra y llegar hasta el soporte base, por lo que deben preverse antes de colocar la capa de regularización o de lo contrario resultará imposible ejecutarlas correctamente.

La mala ejecución u omisión de las juntas perimetrales es una de las causas más frecuentes del levantamiento de embaldosados.

6. JUNTAS DE DILATACIÓN

Tienen por objeto permitir las deformaciones diferenciales originadas por las variaciones térmicas entre las baldosas, la capa de adhesivo, y el soporte.

La anchura mínima será de 5 mm y deben estar convenientemente ejecutadas y funcionar como tales, es decir, deben ser flexibles, impermeables, bien adheridas y deben llegar hasta el soporte.

7. JUNTAS DE COLOCACIÓN

Las juntas de colocación ejercen una importante función estética, realzan la belleza propia de las baldosas cerámicas y compensan sus pequeñas variaciones dimensionales.

Implican la mutua separación repetida regularmente entre las baldosas individuales, recomendándose el empleo de crucetas y cuñas para conseguir una perfecta alineación de las baldosas

3.FIXING

Depending on the nature of the ceramic products (porcelain, stoneware or tile) a special type of placement will be used accordingly.

Placing in thin layer, it is the latest development technique, suitable for any type of tile and compatible with any support.

Placement is usually done on a previously evened facing layer, whether on plastered walls or mortar bases in floors.

There are suitable adhesives for each type of support according to the UNE EN 12004.

The cementitious adhesives or adhesive mortars, adhesives and reaction resin adhesives are used in thin layer, with the advantage of higher adjustment time, greater deformability in the support and better adhesion.

You should keep in mind that the support base is usually a continuous surface subjected to contraction and expansions caused by temperature changes, structural movement or retraction of the cement itself. Therefore, a perfect execution of the joints ensures that these natural movements of the support base would not move to the tiled surface.

4.STRUCTURAL JOINTS

The sizing of the structural joints must be detailed fully in the building project, and should be fixed by the architect or specialist.

Structural joints between tiles must reach the support, and its width should be at least that of the structural joint stand.

Structural joints are finished filling them with permanently elastic materials.

5.PERIMETER JOINTS

Their objective is to insulate the floor tiles, along with the corresponding adhesive layer, from other covered or paved surfaces such as wall-floor connections or meeting points with other construction elements such as pillars, windows or doors.

Its mission is to prevent both the ceramic material as well as the adhesive from getting into contact with the mentioned elements, in order to prevent the accumulation of tensions.

The joints between walls and floors are always needed for surfaces bigger than 7 m². Sealing width of 5 to 10 mm is recommended, which is hidden by a baseboard, or cladding.

The perimeter joints must be properly done and function as such, meaning, they must be free of building materials residues and reach the base support, which must be taken into consideration before placing the leveling layer otherwise it would be impossible to execute it correctly. Improper performance or omission of perimeter joints is one of the most common causes of lifted tiles.

6.EXPANSIÓN JOINTS

They are intended to allow the differential deformations caused by thermal variations among the tiles, the adhesive layer and the support.

The minimum width is 5 mm and must be properly implemented and function as such, meaning they must be flexible, waterproof, well bonded and should be able to reach the support.

7.INSTALLATION JOINTS

Installation joints play an important aesthetic function, enhance the inherent beauty of the ceramic tiles and compensate for their small size variations.

Repeated regularly involve mutual spacing between the individual tiles, recommending the use of spreaders and wedges for a perfect alignment of the tiles and the constancy of the joints

y la constancia del espesor de las juntas.

Contribuyen a absorber las deformaciones producidas por el soporte y moderan las tensiones que se generan cuando son sometidas a carga. Si las piezas se colocan a tope o hueso, y por tanto, no existe la acción moderadora de las juntas, las tensiones acumuladas pueden llegar a producir el levantamiento de las baldosas.

Son especialmente necesarias cuando baldosas rectangulares se colocan TRABADAS o en ES-PIGA, ya que minimizan las cejas que esta técnica de colocación genera. Existe en el mercado una amplia variedad de materiales de rejuntado, que permiten adecuarse a diversos tipos de baldosas y ambientes. Como norma general se recomiendan materiales del tipo J2 según especificaciones de la norma europea EN 12004.

La colocación sin juntas es desaconsejable desde cualquier punto de vista técnico por los riesgos que supone de producir estados patológicos en los recubrimientos.

Como norma general se recomienda la colocación con junta de 3 ó 4 mm, y en ningún caso debiera ser inferior a 2.0 mm.

La colocación trabada o en espiga requiere juntas mínimas de colocación entre baldosas de 5.0 mm.

Para rejuntar baldosas de gres porcelánico no deben elegirse productos coloreados con "negro de humo" (carbón micronizado), ya que su empleo podría impedir la limpieza de la superficie revestida, especialmente cuando se trata de modelos de tonos claros y de producto pulido.

8. SISTEMAS DE NIVELACIÓN

Para lograr una colocación totalmente plana en pavimentos cerámicos, se aconseja el uso de calzos y cuñas autonivelantes. Este sistema además de nivelar las baldosas adyacentes, reduce los tiempos de repaso y colocación de las piezas cerámicas.

Está especialmente recomendado para la instalación de pavimentos y revestimientos con junta mínima, así como para la colocación de pavimentos cerámicos de gran formato y revestimientos rectificados.

No se admitirán reclamaciones de material colocado en el que no se hayan seguido las recomendaciones de colocación.

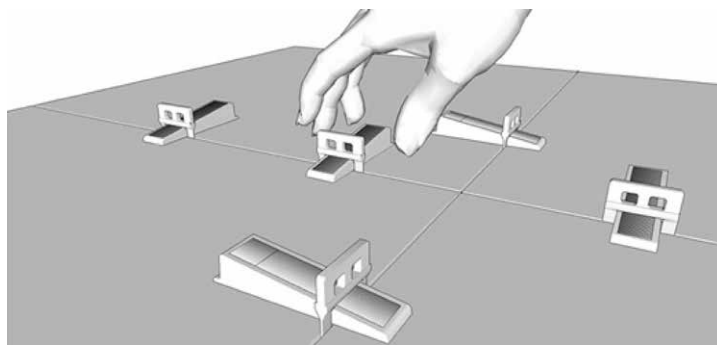

thickness

They contribute to absorb the deformations produced by the support and moderate the tension generated when subjected to load. If the pieces are laid out without any joints, the accumulated tensions can produce tiles lifting, since there is no moderating action of the boards.

They are necessary in particular, when rectangular tiles are placed in a brick pattern or herring bone layout, as they minimize the eyebrows generated by this placement technique. There is a wide variety of grouts in the market, allowing adaptation to different types of tiles and environments. As a general rule J2 type materials are recommended according to specifications of the European standard EN12004.

Placement without any joints is inadvisable from any technical point of view due to the risks to produce pathological states in the coatings.

As a general rule, the recommended placement is with a joint from 3 to 4 mm, and in no case should be less than 2.0 mm.

The brick pattern or the herring bone pattern layout requires a minimum joint width of 5.0 mm between the tiles.

For jointing porcelain tiles it is advisable not to choose products colored with "black smoke" (micronized coal), because they could prevent the coated surface from cleaning, especially when it comes to models of light colors and polished products.

8. LEVELLING SYSTEM

To achieve a complete flat laying on ceramic floor tiles, we advise the use of auto leveling systems. This system, besides leveling the adjacent tiles, reduces the time of ceramic tile setting as well.

It is specially recommended for wall tiles and floor tiles installation with a minimum joint, as well as for big size porcelain tiles and rectified wall tiles.

No claims of tiles already installed will be accepted if the installation recommendations have not been taken into consideration.



KEROS

CERÁMICA

Más información en nuestra web: www.keros.com / For more information: www.keros.com